



Geoengineering Cost Analysis

Final Report

Prepared Under Contract to
The University Of Calgary

Contract Number: UC01-001

Aurora Report Number: AR10-182

October 30, 2010

Prepared by
Justin McClellan
James Sisco, Brandon Suarez, Greg Keogh
Aurora Flight Sciences Corporation
1 Broadway, 12th Floor
Cambridge, Massachusetts 02142

www.aurora.aero

Executive Summary	3
1 Introduction	6
1.1 What is Geoengineering?.....	6
1.2 Introduction to This Study.....	6
1.3 Chemistry Considerations Affecting Dispersal	7
2 Geoengineering Concept of Operations.....	8
3 Basis for Cost Models	10
3.1 RAND DAPCA IV Cost Estimating Relationships.....	10
3.2 Assumptions and Cost Inputs.....	17
3.3 Comparable operating airlines	19
4 Overview of Aircraft Design and Selection	21
4.1 Altitude Capability: Aerodynamics.....	21
4.2 Altitude Capability: Propulsion.....	22
5 Analysis of Existing Aircraft and Results	33
5.1 Assumptions specific to analysis of existing aircraft.....	33
5.2 Choice of Platforms.....	34
5.3 Cost Estimates	35
5.4 Modifications to Existing Aircraft	37
5.5 Conclusions.....	40
6 New Aircraft Design	43
6.1 New Aircraft Assumptions	45
6.2 Uncertainty Analysis.....	45
6.3 Cost Estimates	46
6.4 Conclusions.....	48
7 Airships	50
7.1 Airship Design Considerations and Assumptions.....	50
7.2 Cost Estimates	54
7.3 Conclusions.....	56
8 Non-Aircraft Systems	62
8.1 Rocket Powered Glider	62
8.2 Guns	63
8.3 Floating Platform with Slurry Pipe / Gas Pipe.....	67
9 Conclusions.....	74
9.1 Comparison of All Systems	74
9.2 Recommendations for Future Work	78
10 Appendix	79
10.1 Basing Options.....	79
10.2 HLA Sizing Equations	79
10.3 HLA Architecture Comparisons	81
10.4 Existing HLA Hangars	84

Executive Summary

Geoengineering has been defined as: “the deliberate large-scale manipulation of the planetary environment to counteract anthropogenic climate change.”¹ As Lord Rees, chair of The Royal Society, wrote in the forward to the Society's 2009 report on geoengineering,

“The continuing rise in the atmospheric concentration of greenhouse gases, mainly caused by the burning of fossil fuels, is driving changes in the Earth's climate. The long-term consequences will be exceedingly threatening, especially if nations continue ‘business as usual’ in the coming decades. Most nations now recognize the need to shift to a low-carbon economy, and nothing should divert us from the main priority of reducing global greenhouse gas emissions. But if such reductions achieve too little, too late, there will surely be pressure to consider a ‘plan B’—to seek ways to counteract the climatic effects of greenhouse gas emissions by ‘geoengineering’ ... Far more detailed study would be needed before any method could even be seriously considered for deployment on the requisite international scale. Moreover, it is already clear that none offers a ‘silver bullet’, and that some options are far more problematic than others.”²

Geoengineering may be a means to create a time buffer against catastrophic climate change while long-term emissions reduction actions take effect. One approach is to disperse particulates at high altitude to reduce the effective solar flux entering the atmosphere. Sulfur compounds have been proposed, similar to the compounds emitted during volcanic eruptions that have been found to cool surface temperatures. As shown in Figure 1, the reduction in top-of-atmosphere solar flux is dependent on the quantity of sulfur dispersed per year. Other particulates may also be suitable. This study investi-

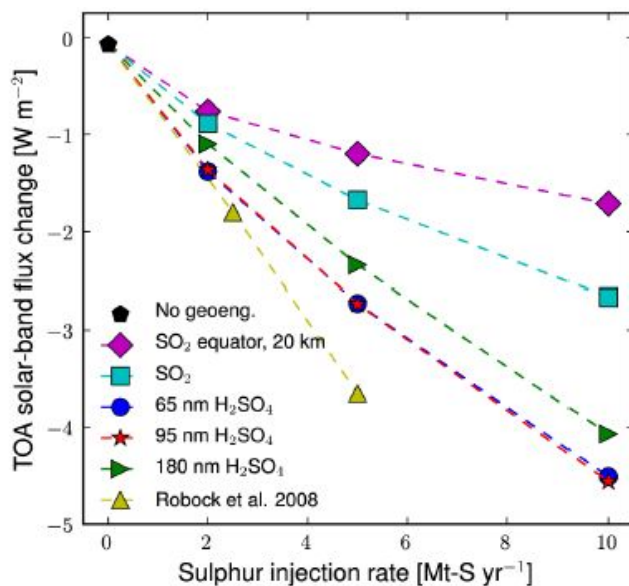

gates means of transporting quantities geoengineering payload to altitude and releasing it at specified release rates. A variety of systems including airplanes, airships, rockets, guns, and suspended pipes are examined with a goal of lifting 1 million tonnes to altitude per year; we also evaluate 3 and 5 MT/year for a few delivery systems.

Figure 1: Reduction in incoming top-of-atmosphere (TOA) solar flux achieved for a given yearly dispersal rate.³

¹ “Geoengineering the Climate: Science, Governance and Uncertainty”, p. 1, The Royal Society, London, September 2009, 98 pp. ISBN: 978-0-85403-773-5

² *Ibid*, p. v.

³ Jeffrey R. Pierce, Debra K. Weisenstein, Patricia Heckendorn, Thomas Peter, and David W. Keith. “Efficient formation of stratospheric aerosol for climate engineering by emission of condensable vapor from aircraft” *Geophysical review letters*, volume 37, doi: 10.1029/2010GL043975

Existing aircraft are evaluated based on cost of acquisition and operations. An in-depth new aircraft design study and cost analysis was conducted to determine the cost of developing and operating a dedicated geoengineering airplane type. Similarly, an airship design study and cost analysis was conducted. Finally a survey of non-aircraft systems was conducted to determine how their costs compare to aircraft and airships.

Yearly costs of 1M tonne geoengineering operations for all the systems examined are presented in Figure 2. Some systems are easily written off due to extremely high costs. Rocket based systems are not cost competitive due to the large number of launches required and the impact of occasional rocket failures on required fleet size. A system based on 16" naval Mark 7 guns was analyzed and compared to previous work by the National Research Council.⁴ This system requires large numbers of shots increasing projectile costs and driving yearly costs over \$100B. Gun costs become more competitive if the projectile payload fraction can be increased from about 10% for a standard shell to 50%. With this and a few improvements over the 1940-era Mark 7 gun yearly costs are still in the \$20B range.

⁴ United States. National Academy of Sciences, National Academy of Engineering, Institute of Medicine. Policy Implications of Greenhouse Warming- Mitigation, Adaptation, and the Science Base. Washington: National Academy Press, 1992

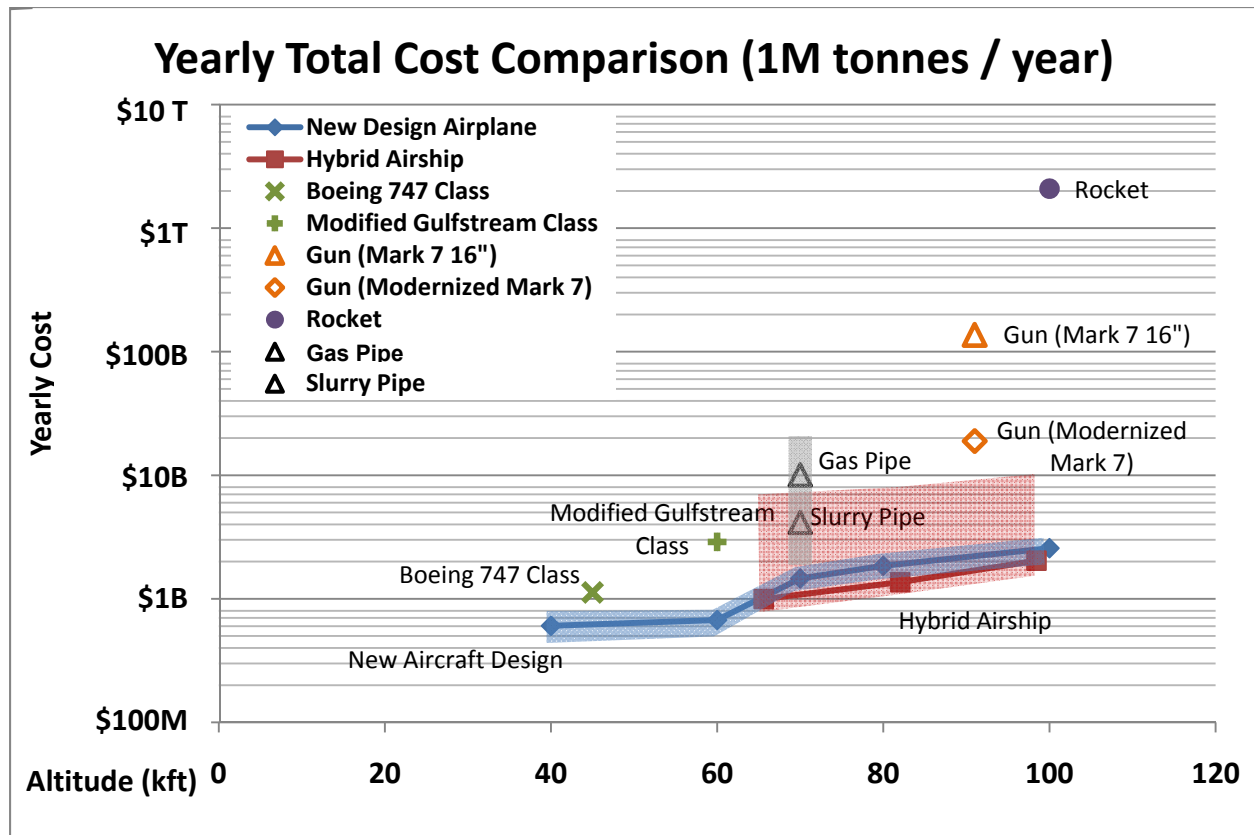

Figure 2: Yearly cost (including depreciation, interest, and operations costs) for 1M tonne per year geoengineering

Planes are estimated to have yearly costs including interest payments and depreciation for a 1M tonne up-mass costing about \$1B to \$2B for a new airplane design. Baseline airships costs are competitive with airplanes but with no airships currently operating above 20kft, their technological maturity is low increasing cost uncertainty. As altitude increases past 60kft, airplanes become limited by current propulsion systems and may require expensive engine development efforts. Airships do allow more propulsion flexibility but their large surface area complicates operations in the presence of high altitude winds and wind shear while transiting the jet stream. Existing airplanes are capable of efficient lower altitude geoengineering operations but with modifications altitude can be pushed to the 65kft. This comes at a cost of additional engines and larger fleet size due to longer missions. Pipes suspended by floating platforms do provide low recurring costs to pump a liquid or gas to altitudes as high as 70kft, but the research, development, testing, and evaluation costs of these systems are high and carry a large uncertainty. The pipe system’s high operating pressures and tensile strength requirements bring the feasibility of this system into question. The pipe itself will require advanced materials and significant engineering to withstand the immense pressures and forces acting on it. Other systems (e.g. sounding rockets) do provide access to high altitude but their costs do not compete with the systems mentioned here.

Airplane geoengineering operations are comparable to the yearly operations of a small airline, and are dwarfed by the operations of a large airline like FedEx or Southwest.

1 Introduction

1.1 What is Geoengineering?

Geoengineering may provide a means to create a time buffer against catastrophic climate change while long-term emissions reduction actions take effect. One approach is to disperse sulfur compounds at high altitude to reduce the effective solar flux entering the atmosphere. This report will evaluate the means of delivering sufficient mass of this or similar material to affect climate change on a global scale.

1.2 Introduction to This Study

The goal of this study is to use engineering design and cost analysis to determine the feasibility and cost of a delivering material to the stratosphere for solar radiation management (SRM). This study does not examine effectiveness or risks of injecting material into the stratosphere for SRM. Its goal is simply to compare a range of delivery systems on a single cost basis.

Key assumptions:

Parameter	Value	Rational
Mass per year	1 Million tonnes	The rough order of magnitude needed for planetary scale SRM. Values of 3M, and 5M also considered for some systems.
Altitude range	40 to 100 kft	SRM is generally thought to be most effective in this altitude range, with current models showing increased effectiveness above 60 kft.
Payload cost	Not considered	
Payload density	1 kg/L	Equivalent to water. Payload density sufficiently large that payload volume can be ignored.
Payload dispersal rate	0.1 to 0.003 kg/m	Release rate per meter flown to obtain ideal particle size. Goal of 0.03 kg/m.

The primary vehicles examined to lift particulate to stratospheric altitudes and disperse them at a predetermined release rate are airplanes and airships; rockets and other non-aircraft methods such as guns and suspended pipes are also surveyed.

Existing airplanes, modified airplanes, and clean sheet designs requiring development and testing are examined. Fleet setup cost analysis looked at costs of starting up a geoengineering operation by purchasing airplanes, designing and acquiring new airplanes or airships, or constructing other systems. Operations cost analysis looked at the fuel costs, electricity costs, personnel costs, maintenance costs of systems. Finally, yearly costs combined operations with depreciation of the system's initial costs as well as financing charges over the 20-year system life.

1.2.1 Glossary

The following is a list of terms and their definitions used in the report:

RDT&E	Research, Development, Testing & Evaluation
Fleet (Acquisition) Cost	Cost to set up new aircraft fleet, including RDT&E and acquisition costs of aircraft. Similarly, cost of developing and constructing non-aircraft systems.
Yearly Operations Cost	Cost of operating aircraft fleet, including maintenance, fuel, personnel, spare parts for 1 year. Similarly, cost operating non-aircraft systems.
Yearly Total Cost	Combined cost of operations and depreciation of aircraft fleet or system over 20-year life as well as 10% interest charge for financing over 20 years.
Regional Dispersal CONOP	Aircraft concept of operations with dispersal taking place in a region close to the aircraft base. Out and back flight path.
Transit Dispersal CONOP	Aircraft concept of operations with dispersal taking place during long transit leg between bases.
Hybrid Airship (HLA)	An airship that (at some altitude) develops lift from aerodynamics in addition to buoyancy

Altitudes are expressed in feet in accordance with *International Civil Aviation Organization* standards. Altitudes for atmospheric chemistry are typically presented in kilometers so where possible, both feet and kilometers are presented. A conversion table is presented below:

Thousands of Feet (kft):	40	60	70	80	100
Kilometers:	12.2	18.2	21.3	24.4	30.5

1.3 Chemistry Considerations Affecting Dispersal

Atmospheric chemistry analysis as well as observation of surface temperatures after large volcanic eruptions has shown that injection of sulfur compounds into the stratosphere reduces incoming solar flux. The mass of sulfur compounds released is directly proportional to the reduction in incoming flux achieved (Figure 3). Current anthropogenic net forcing is $\sim 2 \text{ W/m}^2$.

Figure 3: Reduction in incoming top-of-atmosphere (TOA) solar flux achieved for a given yearly dispersal rate.⁵

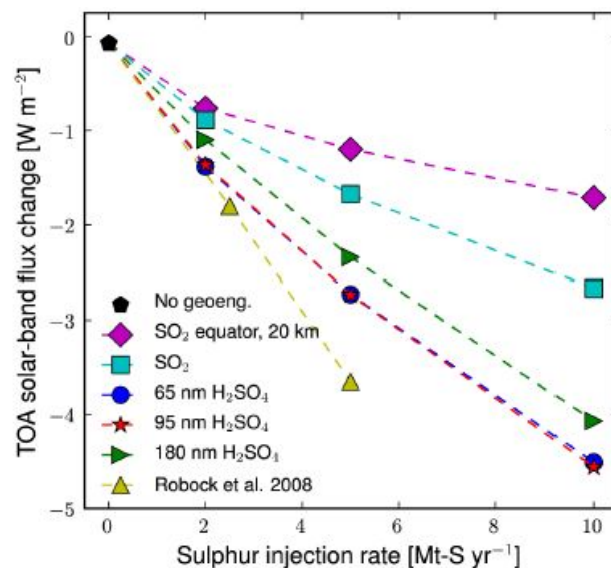

⁵ Pierce et al., op. cit.

For the purposes of this study, a baseline up-mass rate of 1 million tonnes a year is assumed, equivalent to an estimated reduction in flux of 0.6 to 1.3 W/m². Additionally, 3 million tonnes (estimated 0.8 to 2.2 W/m² reduction) and 5 million tonnes (estimated 1 to 3.5 W/m² reduction) mass-rates are also examined to provide an understanding for how the costs of a geoengineering operation scale with yearly up-mass rate.

The effectiveness of geoengineering is strongly dependent on the type or particle and the particle size deployed. Most studies of geoengineering focus on the release of SO₂ or H₂S gas into the stratosphere where over time (~1 month), they are converted to condensable H₂SO₄. Recent work by Pierce et al has shown that directly emitting H₂SO₄ allows better control of particle size⁶ and therefore more effective reflection of incoming flux. For the purposes of this study, we have assumed the geoengineering payload is a liquid with a density of 1000 kg/m³ (In gas pipe analysis, a density of 1.22 kg/m³ is assumed), emitted as a vapor. The larger geoengineering particles, the faster they settle out of the atmosphere. If they are too small, they do not effectively scatter incoming solar flux. The peak scattering effectiveness of H₂SO₄ aerosols is about 0.2 microns (Mie theory). To achieve the proper particle size, the vapor must be emitted at a rate that prevents particles from coagulating into large particles. Analysis⁷ has shown that a release rate of 0.1 to 0.003 kilograms per meter travelled by the aircraft limits coagulation. For the purposes of this study, concepts of operations are designed around a release rate of 0.03kg/m. However, in some cases higher rates are required due to limitations on airplane range or dispersal method.

2 Geoengineering Concept of Operations

This study focuses on airplane and airship operations to the stratosphere to release a geoengineering payload with the goal of reducing incoming solar flux. Airships are also considered for this mission. To provide a comparison to conventional aircraft operations, more exotic concepts such as rockets, guns, and suspended pipes are also examined.

For maximum cooling impact, the particulate payloads are best placed near the equator. This study assumes that the payload is released within latitudes 30°N and 30°S, though North-South basing location had minimal effect on cost. *Transit* operations, flying East-West between equally spaced bases around the equator, were examined as a method to ensure adequate dispersal of the payload around the equator. Global winds aid in East-West dispersal so a smaller number of bases and shorter range systems (referred to as *Regional* operations) can be employed with minimal impact on dispersal. Regional operations allow the dispersal leg length to be dictated by the desired release rate of 0.03kg/m flown. This means the airplanes fly no further than they have to, on the order of 300-800 km, and fuel costs are minimized. Transit operations are not economical as

⁶ Pierce et al., op. cit.

⁷ Pierce et al., op. cit.

the leg length is dictated by the distance between bases (for 8-base operations, legs are approximately 5,000 km) causing release rates to be low and fuel costs to be high. A comparison of regional and transit operations utilizing Boeing 747s (at its service ceiling of 45,000 feet) is as follows:

- Regional: 747s operating regionally from multiple bases
 - 14 airplanes, payload dispersed over 1,500 km cruise leg at a rate of 0.036 kg/m flown
 - \$0.8B for acquisition and \$1B for one year of operations
 - 0.66M tonnes fuel burned per year
- Transit: 747s transiting from 8 bases
 - 24 airplanes, payload dispersed over 5,000 km cruise leg at a rate of 0.012 kg/m flown
 - \$1.4 B for acquisition and \$2.8B for one year of operations
 - 1.6M tonnes fuel burned per year
- Transit: 747s transiting from 4 bases
 - 48 airplanes, payload dispersed over 11,000 km cruise leg at a rate of 0.005 kg/m flown
 - \$2.8B for acquisition and \$4.5B for one year of operations
 - 3.24M tonnes fuel burned per year

Figure 4: Notional basing strategy for a geoengineering effort. Existing civilian and military facilities in Palmdale, USA, Manta, Ecuador, and Perth, Australia are capable of supporting geoengineering support facilities and operations. The prevailing winds, shown as arrows, serve to further distribute the particulate around the equatorial region.

Regional dispersal from several bases provides fuel cost savings and particulate is spread globally via winds. A notional basing strategy is shown (Figure 4) with arrows indicating the direction prevailing winds will carry the released particulate.

Care is taken to choose bases capable of supporting high-tempo geoengineering operations and with the land available to allow any ramp or hanger expansion necessary. It should be noted that the costs of any facility improvement are not included in the cost analysis presented in subsequent sections. DHL recently built a state-of-the-art Central Asia Cargo Hub at Hong Kong Airport, the facility is designed to handle 2.6M tonnes annually and required investment of approximately \$1B.⁸

For aircraft operations, fuel burn is estimated using the mission profile shown in Figure 5, each segment representing a percentage of total fuel burned on the mission.

Figure 5: Mission profile for airplane and airship operations. Each leg represents a percentage of fuel burned during the mission.

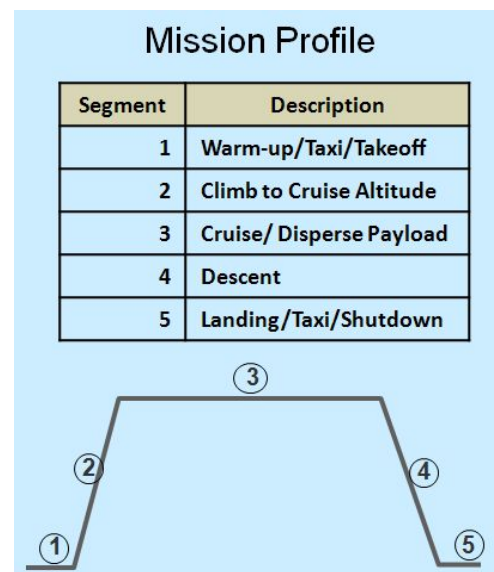

3 Basis for Cost Models

Cost estimates of airplanes and other engineered systems are developed through the use of statistical cost estimating relationships (CER). CERs are based on historical costs of development programs and use one or more input variables such as the empty weight of an aircraft, flight hours per year, or ΔV of a rocket to solve for a variety of output values such as engineering hours, spare parts cost, or cost of personnel. In the case of CERs that output labor hours, a labor rate is used to determine the cost of labor. Payload supply line costs are not included in operations costs (the payload is assumed to be at the air base ready for loading). Air base infrastructure improvement, ramp lease costs, and landing fees are not included in operations or start up costs.

3.1 RAND DAPCA IV Cost Estimating Relationships

The RAND Corporation has developed a set of airplane CERs, the Development and Procurement Costs of Aircraft model, or DAPCA. Originally developed in the late 1960s, the DAPCA CER model is a flexible one, well suited to a cost prediction for a variety of airplane types. It has been updated several times to utilize statistics for more

⁸ [Hong Kong International Airport. Our Business: Air Cargo. July 10th, 2010. <http://www.hongkongairport.com/eng/business/about-the-airport/air-cargo/business-partners.html>](http://www.hongkongairport.com/eng/business/about-the-airport/air-cargo/business-partners.html)

modern airplanes improving accuracy. Research, Development, Testing, and Evaluation (RDT&E) costs are modeled using an inflation updated version of the original RAND model. Daniel Raymer's⁹ modified version of the DAPCA model is used as the basis for the RDT&E cost analysis for airplanes and airships.

The CERs are based on data for historic airplanes that are standard in configuration and built from aluminum. When costing a more complex system, it is necessary to scale the predicted costs by a *Difficulty Factor*. This multiplier scales the labor hours predicted by the CERs according to the relative difficulty to design and produce an airplane that utilizes more advanced composite materials and operates at higher altitude. Difficulty Factors are as follows:

Table 1: Difficulty Factor used to scale labor estimates based on cruise altitude of airplane

Cruise Altitude	Difficulty Factor
< 70,000 ft (< 21.3 km)	1
70,000 – 85,000 ft (21.3 – 25.9 km)	2
> 85,000 ft (> 25.9 km)	3

It can be expected that an aircraft of Difficulty Factor 2 uses larger quantities of composites or titanium, utilizes advanced aerodynamics such as laminar flow wings, and requires roughly double the engineering labor that a more typical aircraft requires. A Difficulty Factor 3 aircraft uses all composites and advanced materials, requires integration of advanced new propulsion systems, and requires roughly three times the engineering labor of a conventional design.

3.1.1 RDT&E Labor Hours and Costs

Below is a discussion of each component of the airplane cost model. Note that the input variables in the equations below are in US Customary units (speeds are in knots). Specific models used for non-airplane systems will be discussed in subsequent sections.

Variables used:

- W_e = Empty weight of aircraft (lbs)
- V_{max} = maximum cruise speed of aircraft (kts)
- N_p = Number of prototypes
- D_f = Difficulty factor

⁹ Raymer, Daniel P. Aircraft Design: A Conceptual Approach. Reston: American Institute of Aeronautics and Astronautics, Inc., 1999

RDT&E Engineering Hours:

$$= 0.0317 * W_e^{0.791} * V_{Max}^{1.526} * \# \text{ Prototypes}^{0.183} * D_f$$

RDT&E Manufacturing Hours:

$$= 28.984 * W_e^{0.74} * V_{Max}^{0.543} * N_p^{0.524} * D_f$$

RDT&E Tooling Hours:

$$= 4.013 * W_e^{0.764} * V_{Max}^{0.899} * N_p^{0.178} * R^{0.066} * D_f$$

Where R is Rate of Production, assumed to be 2 airplanes per month. The labor hours determined from these CERs are multiplied by labor rates to obtain cost. Labor rate assumptions are discussed in the next section. The following CERs were modified by Raymer¹⁰ to provide costs in FY 1999 dollars. These costs are then scaled by 1.30 to adjust them to FY2010 dollars.

RDT&E Development Support Costs:

$$= 66 * W_e^{0.63} * V_{Max}^{1.3}$$

RDT&E Flight Test Costs:

$$= 1807.1 * W_e^{0.325} * V_{Max}^{0.822} * N_p^{1.21}$$

RDT&E Materials Cost:

$$= 16 * W_e^{0.921} * V_{Max}^{0.621} * N_p^{0.799}$$

RDT&E Engine Development Cost:

As is discussed in more detail in section 4.2, propulsion at high altitude is a significant challenge. Conventional engines can perform well up to altitudes of about 60,000 ft, but beyond that, additional testing, adaptation for special fuel blends, and/or development of modified/new propulsion concepts is required. A custom CER was developed to model the increasing development cost as airplane's cruise altitude is increased. The basis for this scaling is discussed in detail in section 4.2.1.

Variables used:

T = Thrust per engine (lbf)

¹⁰ Raymer, Daniel P. Aircraft Design: A Conceptual Approach. Reston: American Institute of Aeronautics and Astronautics, Inc., 1999. Pg 586 - 587

N_e = Number of engines per aircraft
 T_i = Temperature at the turbine entrance (R)
 M_{max} = Maximum Mach number of the aircraft

< 45,000 ft (13.7 km): Basic RAND engine procurement cost model¹¹

$$= (2251 * (0.043 * T + 243.25 * M_{max} + 0.969 * T_i - 2228)) * (N_p * N_e)$$

45,000 – 65,000 ft (13.7 – 19.8 km): Basic procurement model doubled to account for recertification and testing of engine

$$= 2 * (2251 * (0.043 * T + 243.25 * M_{max} + 0.969 * T_i - 2228)) * (N_p * N_e)$$

65,000 – 80,000 ft (19.8 – 24.4 km): Basic procurement model doubled, plus \$1B for modifications and adaptation to non-standard fuel

$$= 1,000,000,000 + [2 * (2251 * (0.043 * T + 243.25 * M_{max} + 0.969 * T_i - 2228)) * (N_p * N_e)]$$

> 80,000 ft (> 24.4 km): Basic procurement model doubled, plus \$2B for new technology development

$$= 2,000,000,000 + [2 * (2251 * (0.043 * T + 243.25 * M_{max} + 0.969 * T_i - 2228)) * (N_p * N_e)]$$

This yields an engine development cost function that varies strongly with altitude. The results of this function are compared to several engine development efforts (Figure 6). The cost function matches the historic development efforts well when the service ceilings are adjusted to more realistic engine flame out altitude based on similar engine and aircraft capabilities¹².

¹¹ Birkler, J. L., Garfinkle, J. B., and Marks, K. E., "Development and Production Cost Estimating Relationships For Aircraft Turbine Engines," Rand Corp., Report N-1882-AF, Santa Monica, CA, 1982

¹² During a 1963 altitude record setting flight by Commander Leroy Heath and Lieutenant Larry Monroe, their A3J-1 Vigilante flamed out at 91,000 ft. During a 1975, record setting flight, lightened F-15 "Streak Eagle" flamed out at 98,000 ft. These flame out altitudes are reduced to 80,000 ft to allow a more stable combustion in the burner.

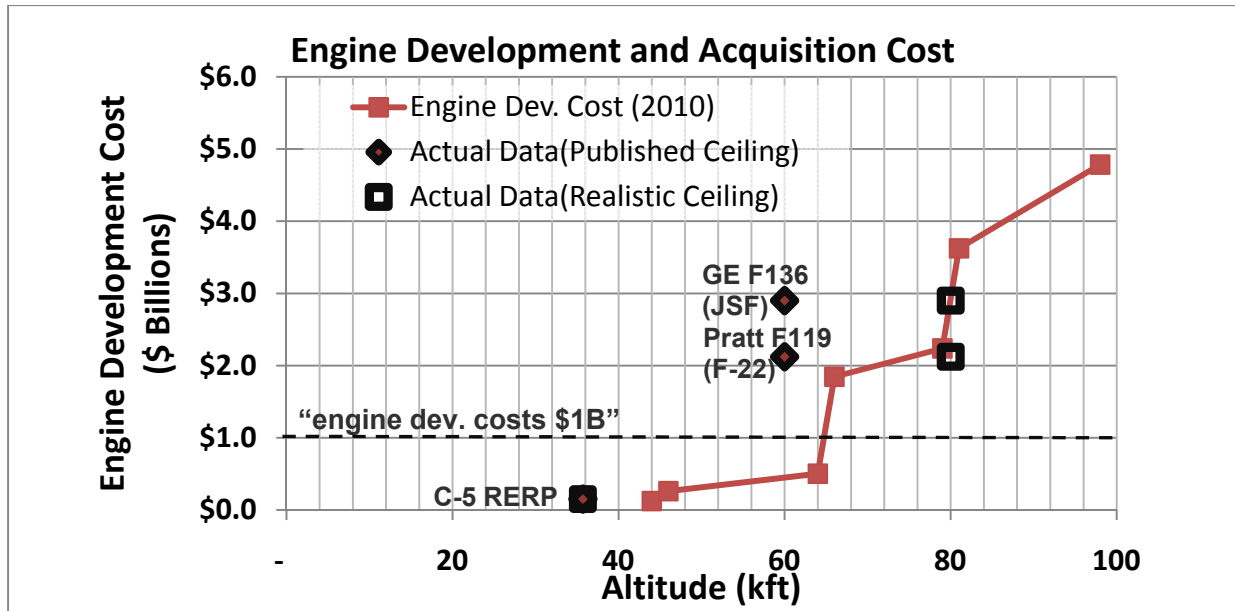

Figure 6: Estimated engine development cost CER result compared to several recent engine development efforts. The dashed line represents the cost typically quoted when engine manufacturers are asked how much it will cost to develop a custom engine.

RDT&E Avionics Development Cost:

For unmanned vehicle = RDT&E Cost * 0.10

For manned vehicle = RDT&E Cost * 0.05

3.1.2 Production Labor Hours and Cost

The following are the cost models for production costs. N_p is equal to the number of aircraft produced.

Production Engineering Hours:

$$= 7.07 * W_e^{0.777} * V_{Max}^{0.894} * N_p^{0.163} * D_f$$

Production Manufacturing Hours:

$$= 10.72 * W_e^{0.82} * V_{Max}^{0.4846} * N_p^{0.641} * D_f$$

Production Tooling Hours:

$$= 8.71 * W_e^{0.777} * V_{Max}^{0.696} * N_p^{0.263} * R^{0.066} * D_f$$

Where R is Rate of Production, assumed to be 2 airplanes per month. The labor hours determined from these CERs are multiplied by labor rates to obtain cost. Labor rate assumptions are discussed in the next section. The following CERs were modified by

Raymer to provide costs in FY 1999 dollars. These costs are then scaled by 1.30 to adjust them to FY2010 dollars.

Production Materials Cost:

$$= 16 * W_e^{0.921} * V_{Max}^{0.621} * N_p^{0.799}$$

Production Engine Development Cost:

During the production phase, the engines costs are modeled using the basic RAND engine procurement cost model:

$$= 2251 * (0.043 * T + 243.25 * M_{max} + 0.969 * T_i - 2228) * (N_p * N_e)$$

Production Avionics Development Cost:

Avionics are typically between 5% and 25% of total airplane cost depending on sophistication. For this study the following relations are used:

- For unmanned vehicle = Production Cost * 0.10
- For manned vehicle = Production Cost * 0.05

3.1.3 Fleet Size

Fleet size is driven by the mass of payload carried to altitude per year, the sortie duration, and the availability of the aircraft. Sortie duration includes block time (in minutes), the time from when the “blocks” are removed from the airplane’s wheels at the beginning of a sortie until they are returned to the wheels after the sortie, and a turnaround time of 150 minutes to refuel and reload the payload (Commercial airliners typically achieve turnaround times of 60-120 minutes, Geoengineering aircraft may require more time for loading and due to high operational tempo). Block time consists of:

Preflight	10	minutes
Warm-up, Taxi, Takeoff, Climb	30	minutes
Flight Time	variable	minutes
Descent, Recovery	20	minutes
Shutdown	5	minutes

Availability is defined as the percentage of the time the aircraft is mission ready, i.e. when it is not out of service for scheduled or unscheduled maintenance. It is assumed to be 80% for most aircraft. Several more maintenance intensive aircraft (F-15, B-1B) used availability values of 70%.

With the sortie duration known, the following equations are used to determine the required fleet size:

$$\text{Sorties per Day} = \left(\frac{\text{Yearly Mass To Altitude}}{\text{Aircraft Payload}} \right) / 365$$

$$\text{Fleet Size} = \frac{\left[\text{SortiesPerDay} * \frac{(\frac{\text{Blocktime}}{60} + 2.5)}{24} \right]}{\text{Availability}}$$

3.1.4 Operations Costs

Fuel Costs

The duration of the cruise leg is determined from aircraft payload mass, cruise speed, and, desired release rate of the payload. For existing aircraft, the fuel burn rate in pounds per hour is determined and used to solve for the fuel weight for each sortie. For new airplane designs, an engine model is used to determine the thrust specific fuel consumption for the engines, then the thrust required and the mission profile are used to determine the fuel weight for the sortie. The fuel weights are then multiplied by a fuel cost per unit weight. Lubricating oil accounts for about 0.5% of fuel costs and is ignored.

Personnel Costs

Personnel costs include air crews, site managers, maintenance personnel, and logistics personnel.

For existing airplanes, a single pilot and payload operator (missions under 8 hours) are assumed. Their labor rates are multiplied by the number of block hours per year. Similarly, the number of maintenance-man-hours per flight-hour (MMH/FH) for the existing aircraft is used to determine the yearly number of maintenance labor hours and this is multiplied by the maintainer labor rate. Additionally, 4 logistic personnel, 1 site manager per site, and 1 mission director are assumed to work full time and their labor rates are multiplied by 2,080 labor hours in a standard year.

For new aircraft analysis, flight crews cost per block hour including pilots, copilots, and payload operators, are estimated from this CER:

$$\text{Flight crew cost / block hour} = 68 * \left[V_c * \left(\frac{W_{GTOW}}{10} \right)^{0.3} + 172 \right]$$

Where V_c is cruise speed (knots) and W_{GTOW} is gross weight of the airplane. The remaining maintenance, logistics, and managerial personnel costs per block hour are estimated using the following CER:

$$\text{Maintenance, Support cost / block hour} = 139.2 * \frac{\text{MMH}}{\text{FH}}$$

MMH/FH is assumed to be 10 hours per flight hour (unless noted otherwise). The per block hour labor costs are multiplied by the total number of block hours per year (Block Time * Sorties per year).

Spare/Replacement Parts Cost

Approximately 50% of the maintenance costs of an aircraft come from the spare parts, materials, and supplies needed to maintain the aircraft. The following CER is used to estimate these costs:

Variables Used:

- C_a = Cost of aircraft (flyaway cost)
- C_e = cost of engines per aircraft
- N_e = number of engines per aircraft

$$\text{Spare Parts/Supplies / block hour} = 3.3 * \left[\frac{C_a - C_e}{10^6} \right] + 10.2 + \left[58 * \left(\frac{C_e}{10^6} \right) - 19 \right] * N_e$$

$$\text{Spare Parts/Supplies / sortie} = 4 * \left[\frac{C_a - C_e}{10^6} \right] + 6.7 + \left[7.5 * \left(\frac{C_e}{10^6} \right) + 4.1 \right] * N_e$$

These values are multiplied by the number of block hours per year and the number of sorties per year respectively and then added together.

Depreciation and Financing

These costs are not part of operations costs, but they are calculated and used to determine total yearly cost of geoengineering. Depreciation represents the cost of setting up the aircraft fleet, minus the 10% residual value of the aircraft, divided over 20 years. C_f is the total cost of the fleet.

$$\text{Depreciation} = \frac{[C_f * (90\%)]}{20}$$

Interest charges for financing the geoengineering fleet over 20 years are calculated using a 10% interest rate compounded monthly.

$$\text{Finance Cost per Month} = \frac{\left[\left(\frac{10\%}{12} \right) * C_f \right]}{\left[1 - \left(1 + \left(\frac{10\%}{12} \right) \right)^{-20 * 12} \right]}$$

3.2 Assumptions and Cost Inputs

All costs are presented in 2010 dollars. Inflation adjustments are made based on Consumer Price Index values obtained from the Department of Labor Statistics. For new design aircraft, 10 MMH/FH is assumed. MMH/FHs for existing aircraft are based on actual values of deployed aircraft and are tabulated below.

Aircraft	Boeing 747	Boeing F-15	Gulfstream C-37A (G500)	Boeing C-17	Rockwell B-1B
MMH/FH	4	22	2	4	4

Most aircraft cost estimates use an availability of 80% to size their fleets. Some more maintenance intensive aircraft like the B-1B and F-15 use an availability of 70%. Operations are assumed to be 24-hours a day, 365 days a year. A single aircraft is capable of multiple sorties per day if time permits.

Fuel and labor contribute to a large portion of operations costs so accurately determining fuel prices and labor rates is important to ensuring accurate cost calculations.

Fuel

Fuel costs are determined based on *Air Transportation Association of America 2009 Monthly Jet Fuel and Consumption Report*. The peak fuel cost for 2009 of \$2.01/gallon or \$0.68/kg (\$0.31/lb) was used in all calculations.

Labor

Labor rates are determined by surveying the rates for various skill sets from several companies on the U.S. General Services Administration website. In some cases, CERs are used to directly determine labor costs. A table of fully burdened labor rates is included below.

Title	Rate Used
Engineer	\$133
Tooling Personnel	\$81
Manufacturing Personnel	\$81
Quality Personnel	\$160
Flight Crew	\$153
Maintenance Technician	\$65
UAV Operator Labor	\$106
Flight Crew	\$280¹³
Mission Specialist	\$228
Site Lead	\$300
Mission Director	\$ 49
Logistics Personnel	\$100

¹³ Existing aircraft are heavier and faster (B747, B-1B) than the new design and therefore require more experienced and higher paid crew

3.3 Comparable operating airlines

To put the magnitude of 1M tonne geoengineering operations in perspective, FedEx's global lift capacity is 4.3M tonnes per year. The baseline geoengineering up-mass rate of 1M tonnes is equivalent to 20-25 fully loaded 747-400F flights per day. Depending on the payload capacity of the aircraft used, sorties per day can vary from 60 to 600. While hundreds of sorties a day may seem like a lot, it should be noted that Atlanta's Hartsfield-Jackson International Airport handles 180-240 flights per hour.

Cost predictions are compared to multiple existing airlines and operators to ensure CER predicted costs are reasonable. Publicly owned companies are chosen for comparison as their annual reports contained detailed cost and operations information. No airline or operator fulfils the exact geoengineering mission described here, so their operations numbers are scaled to allow a direct comparison. In the case of existing aircraft the scale factor is the total tonnage of cargo moved by the comparable operator divided by the total tonnage moved for geoengineering operations. For the new aircraft analysis, the short duration of the missions required a more sophisticated scaling method. Total tonnage moved by the comparable operator is multiplied by the average stage length to obtain tonne-kilometers per year. The typical geoengineering mission performed by the new design airplane is 335 km in length, equating to a 335 million tonne-kilometers per year. The ratio of the comparable operator's tonne-kilometers per year to geoengineering's tonne-kilometers per year is used to scale operations cost. Personnel costs for passenger airlines are scaled by 2/3 to remove counter, reservations, and customer service personnel. Cargolux

Cargolux is the 9th largest cargo airline in the world. It flies a fleet of Boeing 747-400 freighters between over 90 destinations. Detailed operations cost data was obtained from the Cargolux 2008 Annual Report¹⁴. To compute Cargolux yearly flight operations costs, cost associated with sales and marketing, trucking operations, depreciation, and financing are ignored. Due to the similarity between Cargolux's operations and geoengineering using 747s, Cargolux operations costs directly compared against calculated 747 numbers.



Figure 7: Cargolux operates a fleet of 14 Boeing 747 freighters and flew 0.7M tonnes of cargo in 2008. Their operating expenses of \$1.4B in 2008 are close to the predicted costs of operations for a similar geoengineering fleet (Tak, Oct. 2005, http://commons.wikimedia.org/wiki/File:Cargolux_B747-400F.jpg).

¹⁴ Cargolux 2008 Annual Report. <http://www.cargolux.com/Press/AnnualReport.php?nid=112> Accessed 1/29/2010

JetBlue Airlines

JetBlue is a low cost airline that operates a fleet of 110 Airbus A320-200s and 41 Embraer 190s. Because of their homogeneous fleet, Jetblue is a good airline for cost comparison. By assuming a passenger and luggage mass of 113 kg each, JetBlue's 21.9M



passengers in 2008 equal 2.48 million tonnes flown a year. Multiplying this by their average stage length of 1,820 km (1,120 mi), JetBlue flew 4,508 million tonne-kilometers in 2008. Geoengineering represents 7% of the JetBlue tonne-kilometers per year and this is the factor used to scale JetBlue costs for comparison.

Figure 8: JetBlue operates a fleet of 110 Airbus A320-200s and 41 Embraer 190. It flew 22M passenger in 2008 on an average leg stage of 621 km and had operating expenses equal to \$143M (J. Kurgel, Sept. 2009.

http://commons.wikimedia.org/wiki/File:Greater_Rochester_International_Airport_JetBlue_A320_at_B2.jpg).

Mesa Air

Mesa Air is a regional airline that operates a fleet of 28 Bombardier CRJ100/200s, 20 CRJ700s, 38 CRJ900s, and 16 Dash 8-200s. Their fleet of smaller regional aircraft and short stage length makes Mesa a good airline for comparison. Again assuming a passenger and luggage mass of 113 kg each, Mesa's 15.9M passengers in 2008 equal 1.81 million tonnes moved a year. Dividing this by their average stage length of 621 km (385 mi), Mesa flew 1,122 million tonne-kilometers in 2008. Geoengineering represents 30% of the Mesa tonne-kilometers per year and this is the factor used to scale Mesa costs for comparison.

Southwest Airlines

Southwest Airlines is a low cost airline that operates a fleet of 537 Boeing 737s (-300, -500, -700). Their homogeneous fleet and short stage length makes Southwest a good airline for comparison. Southwest's 86.3M passengers in 2009 equate to 9.75 million tonnes moved a year. Multiplying this by their average stage length of 1,023 km (635 mi), Southwest flew 9,977 million tonne-kilometers in 2009. Geoengineering represents 3% of the Southwest tonne-kilometers per year and this is the factor used to scale Southwest costs for comparison.

Geoengineering operations represent only 3% of the tonne-kilometers flown by Southwest Airlines each year. Even the smaller Mesa Air flies over 3 times the tonne-kilometers of 1M tonne geoengineering operations. When the comparable airlines operating costs are scaled appropriately, operators spend about \$200M each year on fuel,

crew, and maintenance. This agrees well with the \$200-400M operations costs obtained for Geoengineering at commercial aviation altitudes. Costs and scale factors for the comparables are presented below in Table 2.

Table 2: Comparable commercial airline operations costs. Costs are normalized based on yearly tonne-kilometers flown per year.

	CargoLux	Alaska Airlines	Southwest	Mesa Air	JetBlue
Load Carried (mt)	0.70	1.90	9.75	1.81	2.48
Avg Segment (km)	10895	1575	1023	621	1820
Millions of ton-km per year	7659.0	2991.6	9977.3	1122.3	4508.1
Scaling Ratio:	1.00	0.11	0.03	0.30	0.07
	Cost / Day	Cost / Day	Cost / Day	Cost / Day	Cost / Day
Cost Fuel,oil	\$ 2,559,000	\$ 356,000	\$ 233,000	\$ 423,000	\$ 275,000
Cost crew	\$ 391,000	\$ 151,000	\$ 197,000	\$ 198,000	\$ 94,000
Cost maint,parts	\$ 279,000	\$ 46,000	\$ 57,000	\$ 214,000	\$ 26,000
Total Yearly Cost:	\$ 1,178,485,000	\$ 201,854,000	\$ 177,349,000	\$ 304,935,000	\$ 143,961,000

* Geoengineering millions of tonne-km per year: 335

4 Overview of Aircraft Design and Selection

Typical commercial aircraft operate at 10.6 km (35kft) to 12.1 km (40kft); advanced subsonic military aircraft routinely operate at 19.8 km (65kft). Above about 19.8 km, heavier than air flight becomes challenging due to the extremely low air density found at altitude. At 19.8 km air density is only 8% of what it is at sea level. Special wing designs, light weight per unit wing area, and engines capable of sustaining flames in low oxygen environments are required to achieve high altitude flight.

4.1 Altitude Capability: Aerodynamics

An aircraft's maximum altitude is limited by multiple factors. Operationally, airplane ceiling is defined as the altitude where the airplane's climb rate drops below 100 ft/min. While this is a very useful metric, for geoengineering absolute ceiling may be more applicable, especially when modifying airplanes to achieve greater altitude.

The primary aerodynamic phenomenon limiting an airplane's ability to continue climbing are stall and maximum Mach number. Stall is defined as the reduction in lift generated by a wing as the flow over the top of the wing separates from the wing surface. Stall is dependent on the speed and the density of the air passing over the wings. As altitude is

increased and the air gets thinner, the airplane must fly faster to generate enough lift to counteract the force of gravity without stalling. In other words, the airplane's minimum speed (stall speed) increases with altitude as air density decreases. Maximum Mach¹⁵ number is the maximum speed the airplane can fly at without generating shock waves as air flow curving around the wings and fuselage locally goes supersonic. If shocks form, the airplane can become difficult or impossible to control and can be structurally damaged.

As altitude is increased, the Mach number at which the airplane stalls increases while the maximum Mach number the airplane can withstand remains constant. The airplane stall Mach number and maximum Mach number converge at its theoretical maximum altitude. As this maximum altitude is approached, the acceptable speed range to maintain steady level flight shrinks. This is referred to as coffin corner because flying a little too fast or too slow can have disastrous consequences.

Best Case Flight Envelope for 747-400

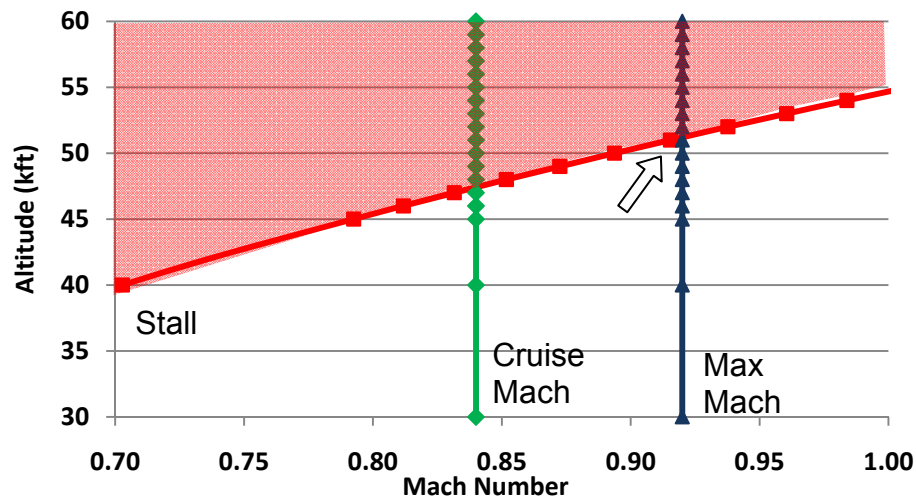

Figure 9: Theoretical Coffin Corner (arrow) for a Boeing 747 is defined as the altitude at which the stall Mach number (at max weight) and maximum Mach number converge.

4.2 Altitude Capability: Propulsion

As previously mentioned, this study examines an altitude range identified for geoengineering operations from about 19.8 km (60kft) to 30.5 km (100 kft). This is at or above the upper end of the operational range of most existing airplanes and therefore imposes

¹⁵ Mach number is a measure of aircraft speed, defined as the ratio of the aircraft's speed to the local speed of sound at altitude

unique constraints upon the design and operation of the dispersal aircraft and its sub-systems. In particular, propulsion system performance and operability are very strongly influenced by its operational altitude. Due to the critical role the propulsion system plays in aircraft performance, aircraft capability may be limited as a result. This subsection provides a qualitative (and in some cases quantitative) outline of the implications and limitations of operation in this altitude range on propulsion system design and performance.

4.2.1 Technology Categories

Aurora believes that aircraft propulsion system technology may be grouped in four categories based on maximum operational altitude: 1) up to 13.7 km (45 kft); 2) between 13.7 and 19.8 km (45 and 65 kft); 3) between 19.8 and 24.4 km (65 and 80 kft); 4) above 24.4 km (80 kft). To extend a system's maximum operational altitude from one category into the next requires a step change in technology as well as cost. It should be noted that these altitude limits represent rough estimates of technology transition points and are meant to serve as guidelines rather than hard limits. A description of the base technologies assumed for each of the four categories is contained below along with a detailed analysis of thrust lapse with altitude for several "off-the-shelf" engines.

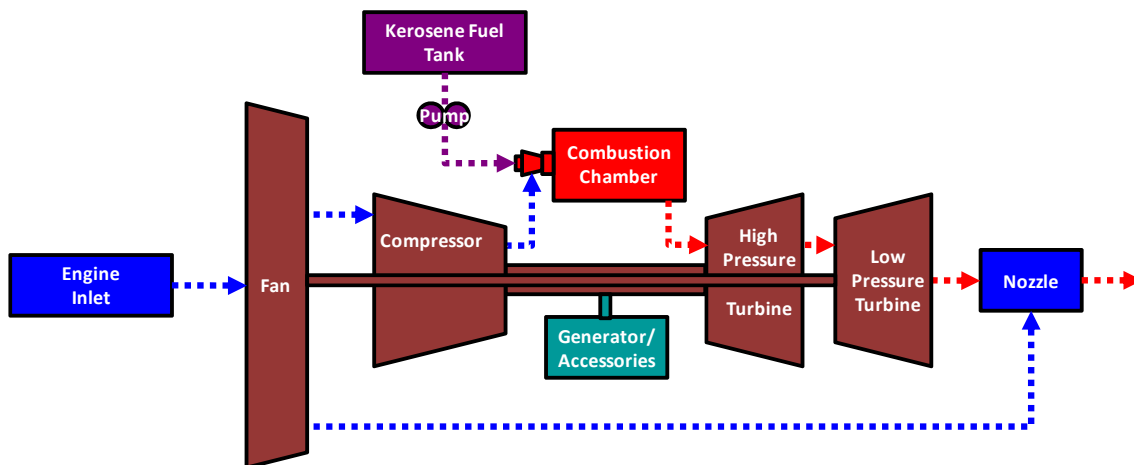

Figure 10: Simplified schematic of a turbofan engine.

A simplified schematic of a typical turbofan engine is shown in

Figure 10. A key component of a turbofan system is the fan itself which is the primary thrust producing element of the system. The fan entrains a large mass flow of ambient air and compresses it slightly (a typical fan pressure ratio is about 1.8) feeding a portion of the flow to the engine core, but with the majority sent to a nozzle producing thrust. The bypass ratio defines the ratio of fan mass flow which is routed to the nozzle to that of the core, and can range from slightly less than one to ten or more depending on the application. The engine core consists of a compressor, a combustor, and a high pressure turbine run on a single shaft. The low pressure turbine is used to drive the fan itself on a second shaft and is considered part of the engine core. The core flow also

produces significant jet thrust. Most often the core and bypass flows are mixed in a single nozzle, as shown in

Figure 10, but in some cases may be fed to separate nozzles.

Turbofan Propulsion System (up to 13.7 km, 45 kft)

An “off-the-shelf” turbofan propulsion system may be used to propel an aircraft intended to operate at a maximum altitude of 45 kft or less. In terms of technology “off-the-shelf” is meant to indicate that an existing turbofan engine would require little to no modification to operate at these altitudes as most of these engines are designed to operate in this range. These off-the-shelf engines most often run with kerosene-based jet fuels such as Jet-A. Off the shelf engine development costs are minimal; costs simply include the cost of engines for the prototype aircraft. These costs are modeled using an engine acquisition cost estimating relationship (CER) based on thrust, turbine inlet temperature, and number of engines purchased.

Modified Turbofan Propulsion System (13.7 to 19.8 km, 45 to 65 kft)

The performance of many turbofan components, specifically the fan, compressor, and combustor, are very sensitive to operational altitude and may ultimately limit the engine’s operational ceiling. Fan and compressor pressure ratio and efficiency will decrease due to increased fluid dynamic losses as the pressure and Reynolds number decreases. More specifically, flow separation at the blades and compressor instabilities, such as surge, may become more prevalent. As combustor temperature and pressure decreases it also becomes more difficult to maintain flame stability as chemical kinetics and vaporization rates slow significantly. As a result, the range of operating fuel-to-air mixture ratios at which stable combustion may be achieved narrows, imposing limits on engine throttleability and operating envelope.

To improve performance and extend the altitude ceiling above 45 kft to about 65 kft, existing turbofans may be modified through a combination of component development, operational modification, and engine testing to characterize performance. For example, the Rolls-Royce AE3007 engine, which is used on the Embraer 135/140/145 family of aircraft, is modified (AE3007H) for high altitude operation up to 70 kft in the Global Hawk unmanned aerial vehicle (UAV) primarily through the development of a modified turbine section to increase flow capacity, and a modified Full-Authority Digital Engine Control (FADEC) system.¹⁶ Testing of the modified engine showed that the engine is capable of operating reliably up to 65 kft with constraints on throttle transients.¹⁶ This example illustrates that it is combustion stability which most often dictates the altitude limitations of a turbofan engine. Engine development costs in this category are modeled

¹⁶ Schelp, T. M., Corea, V. A., and Jeffries, J. K., “Development of the RQ-4A Global Hawk Propulsion System,” AIAA Paper 2003-4680, 39th AIAA/ASME/SAE/ASEE Joint Propulsion Conference and Exhibit, Huntsville, AL, 20-23 July, 2003.

by doubling the prototype aircraft engine acquisition CER cost to account for the additional testing and of the engine to verify its operating envelope and combustion stability.

Advanced Turbofan Propulsion System (19.8 to 24.4 km, 65 to 80 kft)

At about 65 kft the pressure in a modified turbofan combustor becomes too low to adequately stabilize a kerosene-based flame. To extend operation to higher altitudes supplemental fuels that provide high kinetic rates in low pressure air, such as pyrophorics which ignite spontaneously in contact with oxygen, are needed to enhance flame stability. Limited detail exists in the literature regarding the fuels used for this purpose and the techniques by which they are introduced into the combustor, but it is believed that such techniques are used on General Electric's F118-GE-101 engine¹⁷ used in the U-2 aircraft, which has a stated altitude limit greater than 70 kft.¹⁸ Implementation of this technique would require incorporation of tankage and a delivery system, FADEC modification, advanced combustor development, and extensive test characterization. In addition, modifications to the fan, compressor, or turbine may be required to improve performance at these high altitudes. For example, the fan used on the F118-GE-101 is modified from the version used on its predecessor, the F110, for high altitude operation.¹⁷ Engine development costs in this category are assumed to be \$1B plus double the prototype engine acquisition CER cost. This accounts for cost of any R&D required to modifying the engine as needed as well as extensive testing verifying the engines operating envelope. Another consideration for operation at these altitudes is the thermal stability of kerosene-based fuel. Alternative fuel blends may be required to prevent freezing of the fuel and to maintain fuel stability as it pertains to engine cooling. The F118-GE-101 runs on a special fuel, called Jet Propellant Thermally Stable (JPTS), to combat these issues. As a result, fuel costs for operations in this over 65kft are doubled to account for additional cost of JPTS-type fuels.

Alternative Propulsion System (above 24.4 km, 80 kft)

Above 80kft air density and oxygen concentrations become so low that even the advanced turbofan engines discussed above do not perform adequately. At these altitudes alternative propulsion systems are required such as: a) rocket-based systems that carry both fuel and oxidizer, which are burned in a combustion chamber and expanded through a nozzle to produce jet thrust, b) a new turbofan system designed specifically for high altitudes, i.e. fan, compressor, combustor, etc., and configuration to run on a highly reactive alternative fuel, or c) a reciprocating engine system which burns a fuel and oxidizer to drive a piston(s) which produces power to drive a propeller. In the case

¹⁷ General Electric F118, Jane's Aero-Engines, Issue 22, 2007, pp. 593.

¹⁸ U.S. Air Force U-2S/TU-2S Factsheet, <http://www.af.mil/information/factsheets/factsheet.asp?id=129>, accessed April 27, 2010.

of the first two options these could be installed as a secondary propulsion system on the aircraft and run only above 80 kft or so, while an advanced turbofan system could be used to propel the vehicle from sea level up to this transitional altitude. Due to the low air density levels at these high altitudes the inlet area required for a given thrust level at high altitudes will provide significantly more air flow than is needed for the same thrust at lower altitudes. Consequently, a smaller engine may be more appropriate for low altitude operation. Aurora has been developing a propulsion concept called the Hydrazine Decomposition Air Turbine (HDAT) to enable aircraft operation at these high altitudes.¹⁹ The concept, shown in Figure 11, decomposes hydrazine in a reactor to hot gaseous products consisting of hydrogen, nitrogen, and ammonia. These gases may be used to drive a turbine, which is not shown in Figure 11, but are ultimately sent to a combustor where the hydrogen is burned with compressed air. The combustion products are then sent through the turbines to drive the fan and compressor before they are expanded through a nozzle to produce thrust. Flame stability is maintained in the combustor through the use of catalytic reactor technology. Preliminary development suggests that the system could operate reliably up to 100 kft. By utilizing a dual combustor²⁰, the engine could operate on conventional fuel at low altitude and transition to hydrazine at high altitude. Above 80kft, it is assumed that a radically modified or new design engine such as the HDAT is required. Development costs are estimated at \$2B plus double the prototype engines acquisition CER cost. Fuel costs are also double due to the use of JPTS-type or other fuels.

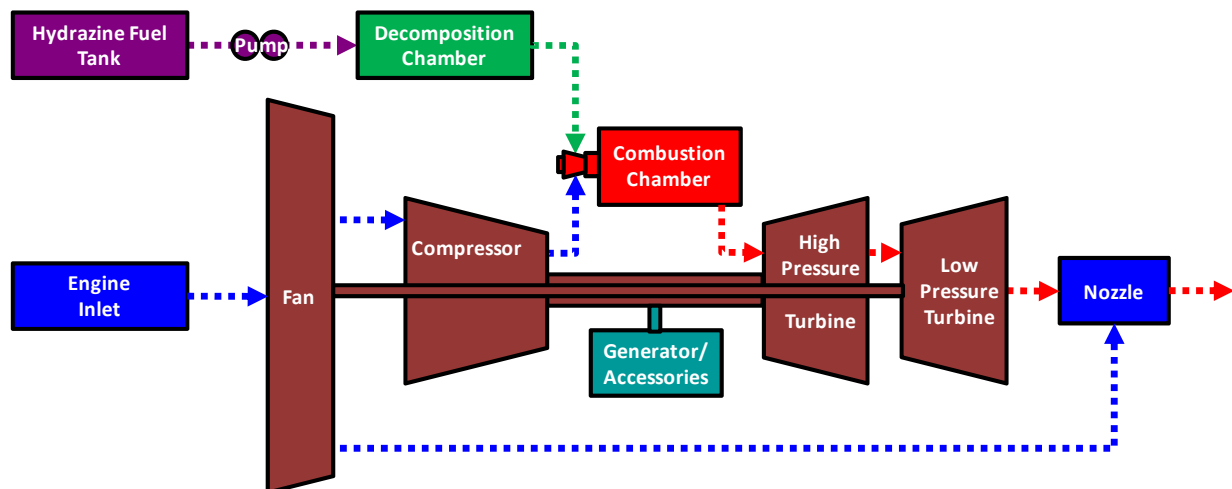

Figure 11: Schematic of Hydrazine Decomposition Air Turbine (HDAT) engine concept in turbofan configuration. Such engines could provide thrust at altitudes in excess of 24.4 km (80kft).

¹⁹ Sisco, J. C., Hollman, J. S., Kerrebrock, J. L., St. Rock, B. E., Kearney, S. J., and Lents, C. E., "Evaluation of Catalytic Reactors for Combustion Stabilization at High Altitudes," AIAA Paper 2010-7061, 46th AIAA/ASME/SAE/ASEE Joint Propulsion Conference and Exhibit, Nashville, TN, July 25-28, 2010

²⁰ Extended Altitude Combustion System – Non-provisional patent application 12/556,202

4.2.2 Thrust Lapse

A typical turbofan engine maintains a fixed inlet area throughout its operational envelope. For this reason, as altitude increases and air density decreases the mass flow rate of air entering into the engine, and consequently its thrust, will decrease. This phenomenon is well known and is commonly referred to as thrust lapse. Along with general aircraft aerodynamic performance, thrust lapse is a primary contributor to defining the altitude limit of a particular aircraft. A turbofan thermodynamic model is used to quantify the thrust lapse of several aircraft engines being considered as part of this study and is used to guide aircraft analysis and design. To simplify the analysis engine performance parameters found in the open literature are assumed to be constant throughout the evaluated altitude range. As discussed above this is not the case, but detailed engine performance numbers are not available.

Three engines are considered as part of this analysis: 1) the General Electric F118-GE-101 used on the Lockheed U-2 ultra-high altitude surveillance aircraft, 2) the Rolls-Royce BR725 turbofan which is planned for use in the Gulfstream G550/650 ultra-long range business jet, 3) the Pratt & Whitney PW2040 used in the Boeing 757 civilian transport and C-17 *Globemaster III* military transport planes, and 4) the Rolls-Royce Trent 900 engine which is the lead engine for the Airbus A380 civilian transport aircraft. The assumed performance specifications for each engine are shown in Table 3; these engines represent a wide range of sizes and bypass ratios.

Table 3: Engine performance parameters assumed in thrust lapse analysis. Asterisk (*) indicates values which have been assumed based on best engineering judgment or unverified sources.

Engine	F118-GE-101 ²¹	RR BR725 ²²	PW 2040 ²³	RR Trent 900 ²⁴
Fan Diameter (in)	47	50	78.5	116
Bypass Ratio	0.9*	4.4	6.0	8.5
Overall Pressure Ratio	27	36*	31.2	39
Fan Pressure Ratio	1.8*	1.8*	1.74	1.8*
Fan Efficiency (%)	87*	87*	87*	87*
Compressor Efficiency (%)	90*	90*	90*	90*

²¹ GE Aviation Turbofan Comparison Chart, http://www.geae.com/engines/military/comparison_turbofan.html, accessed April 28, 2010.

²² Rolls-Royce BR725 Factsheet, http://www.rolls-royce.com/Images/BR725_tcm92-5748.pdf, accessed April 28, 2010.

²³ Pratt & Whitney PW2000 Site, <http://www.pw.utc.com/Products/Commercial/PW2000>, accessed April 28, 2010.

²⁴ Rolls-Royce Trent 900 Factsheet, http://www.rolls-royce.com/Images/brochure_Trent900_tcm92-11346.pdf, accessed April 28, 2010.

Turbine Efficiency (%)	88*	88*	88*	88*
Turbine Inlet Temperature (°F)	2,200*	1,700*	2,200*	2,200*
Sea Level Max Thrust (lbf)	17,000	17,000	43,734	76,500
Engine Weight (lbf)	3,150	4,912*	7,160*	14,190

A plot of maximum thrust versus altitude for the four engines listed in Table 3 is shown in Figure 12 from 45 to 85 kft. A flight speed of 0.85 Mach is assumed for each engine. It should be noted that for those engines missing data points above a certain altitude, for instance the BR725 above 67 kft, indicates that turbine exhaust gases are over expanded and that the cycle does not close at the assumed engine pressure ratio. These thrust estimates represent absolute best case levels as decreases in component performance with altitude will tend to drop thrust further than is indicated here. The magnitude of the thrust lapse over this altitude range is dependent upon the size of the engine, but the relative thrust levels between any two altitude points is independent of the engine size. For instance, the thrust produced by each engine at 60 kft is about 50% of that produced at 45 kft. This indicates how strongly altitude effects engine thrust production and aircraft altitude limits. It is likely that to extend the altitude capability of a notional aircraft, oversized or additional engine(s) may be required to counteract these thrust lapse effects.

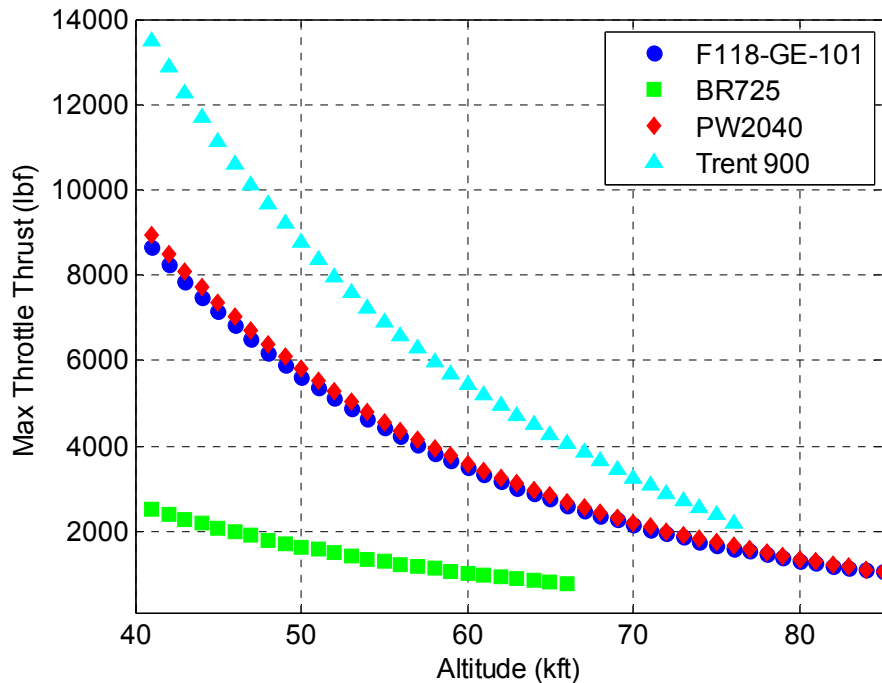

Figure 12: Thrust variation with altitude for four turbofan engines: 1) General Electric F118-GE-101, 2) Rolls-Royce BR725, 3) Pratt & Whitney PW2040, and 4) Rolls-Royce Trent 900. Flight speed of 0.85 assumed for each engine.

4.2.3 Sulfuric Acid Impact on Aircraft

If sulfuric acid is chosen as the particulate material, there is a high likelihood that the through the process of dispersing sulfuric acid into the atmosphere that the dispersing aircraft and its turbofan engines will be subjected to relatively high concentrations of sulfuric acid vapor/aerosols. This could have negative effects on engine performance, component lifetimes, and maintenance costs. A mostly qualitative summary of the potential effects that sulfuric acid may have on aircraft and engine components is presented in what follows.

As a brief aside, it should be noted that a large amount of data concerning the effects of volcanic ash on engine performance was compiled following the Mt. Pinatubo eruption in 1991.²⁵ Ash particles, which are essentially very small pieces of rock, are found to degrade turbofan performance through: 1) abrasion of the forward facing surfaces such as fan and compressor blades which in some cases altered blade flow significantly enough to produce a surge instability in the compressor, and 2) deposition of molten ash on fuel nozzles, nozzle guide vanes, or turbine blades following heating past melting in the combustor. This molten ash was found to cool and solidify on engine components and in many cases blocked fuel nozzle flow and turbine blade cooling flow. In some cases, this blockage triggered engine overheating and/or shutdown.

Specific studies targeting the effects of sulfuric acid on turbofan engines are rarer. A 1990 study details the effects of prolonged exposure to sulfuric acid on aircraft acrylic windshields, which results in accelerated crazing of the acrylic.²⁶ Aircraft exterior polyurethane paint also tends to fade more rapidly when exposed to sulfuric acid.²⁵ Sulfuric acid vapor and aerosols are more benign than volcanic ash in terms of impact damage to forward facing surfaces, but prolonged exposure of fan and compressor blades to sulfuric acid may result in material degradation. Typically fan and compressor blades are manufactured from titanium alloys although some modern fan designs incorporate composite construction. Engine seals, wiring, and hoses may also be susceptible to damage from prolonged exposure to sulfuric acid.

Sulfuric acid will be chemically transformed at the high temperatures present in a gas turbine combustor likely producing sulfur oxides such as sulfur dioxide, SO₂, and sulfur trioxide, SO₃. These sulfur oxides may be further altered at these high temperatures and deposit on turbines blades in the form of sulfate minerals, such as gypsum or anhydrite. These effects have been observed in the longer term following volcanic eruptions

²⁵ Casadevall, T. J., De los Reyes, P. J., and Schneider, D. J., "The 1991 Pinatubo Eruptions and Their Effects on Aircraft Operations," *Fire and Mud: Eruptions and Lahars of Mount Pinatubo, Philippines*, Edited by Newhall, C. G., and Punongbayan, R. S., Philippine Institute of Volcanology and Seismology, Quezon City, Philippines and University of Washington Press, Seattle and London, 1996, pp 1126.

²⁶ Bernard, A., and Rose, Jr., W. I., "The Injection of Sulfuric Acid Aerosols in the Stratosphere by the El Chichon Volcano and its Related Hazards to the International Air Traffic," *Natural Hazards*, Vol. 3, 1990, pp. 56-67.

after the volcanic ash has largely settled out of the atmosphere.²⁵ It should also be noted that most aviation fuels contain some sulfur content, which is regulated to less than 0.3% by mass and is in practice often less than 0.07% by mass.²⁷ This limit is in place due to concerns over the effects of sulfur oxides on downstream engine components, specifically turbine blades which are manufactured from nickel superalloys. An oxide coating is typically applied over the base turbine blade material to protect it from the high temperature, oxidizing environment present in the turbine. Sulfur and sulfur-based molecules are known to attack these coatings leading to corrosion as the base blade material is directly exposed to the turbine environment.

Ingestion of sulfuric acid into the engine will increase the amount of sulfur oxides produced by the combustor and subsequently increase the susceptibility of critical engine components to sulfur related degradation. The established limit on aviation fuel sulfur content (0.3% by mass) is used to facilitate a first cut estimate of the limit on sulfuric acid ingestion by the engine. The total mass of sulfur exiting a notional combustor is estimated assuming that jet fuel with 0.07% sulfur by mass is burned with ambient air containing varying levels of sulfuric acid, H₂SO₄, in the parts per million range (volume %). It is assumed that the fuel and air are mixed at a fuel-to-air mass ratio of 0.035, which is typical for modern gas turbine systems. The total air flow to the engine is adjusted based on the H₂SO₄ content assuming a fixed engine inlet area and flight speed. Results of the computation suggest that 0.3% by mass sulfur content is reached when atmospheric air contains approximately 70 ppm H₂SO₄, as shown in Table 4. Concentrations expected at altitude during geoengineering operations are on the order of 0.01 ppm and pale in comparison to sulfate levels experienced by aircraft landing in polluted regions such as Mexico City or Shanghai.

Table 4: Variation in total sulfur mass exiting turbofan combustor with sulfuric acid levels in air.

Sulfuric Acid in Air (ppm)	Total Mass Sulfur/Mass Fuel (%)
0	0.07
20	0.14
40	0.20
60	0.27
80	0.33
100	0.40

This is an approximate estimate of allowable sulfuric acid ingestion limits. Prolonged operation of the engine in environments exceeding this level will likely lead to accelerated deterioration of turbine blades and other components exposed to the combustor exhaust gases. In addition, operation as these levels will likely necessitate more fre-

²⁷ CRC Report No. 635, "Handbook of Aviation Fuel Properties," Third Edition, 2004.

quent engine inspection, maintenance, and potentially overhaul/replacement. It is recommended that the aircraft be operated in environments with significantly lower sulfuric acid content to avoid the increased costs associated with these maintenance activities.

4.2.4 Thrust Augmentation via Sulfuric Acid Injection

In the early stages of turbojet engine development water injection was evaluated as a method to provide thrust augmentation for takeoff and high Mach operation.^{28,29,30} In these systems water is injected at the inlet of the compressor and produces increased thrust by: 1) increasing the overall mass flow through the engine, and 2) increasing the overall pressure ratio of the engine.^{28,29} Pressure ratio gains are brought about not only due to the increased mass flow through the compressor, but also the water's ability to cool the air, especially when the water is heated to saturation levels. This intercooling effect acts to reduce compressor input power requirements, or alternatively increases compressor specific speed assuming constant shaft speed, resulting in an increased compressor pressure ratio.^{28,29} To combat the potential of the water freezing in operation at altitude or in cold weather alcohol-water mixtures are evaluated for use in practical systems. Augmented thrust ratios of about 1.2 are achieved in operation at water-alcohol to air ratios of approximately 0.1.³⁰ Although the approach is capable of providing significant thrust increases it was replaced in favor of the thrust augmentation approach commonly used today whereby additional fuel is burned in the oxygen rich turbine exhaust gases (afterburning). By this approach similar thrust increases may be achieved with less injected flow (due to the fuel's high heat of reaction) and with less mass of additional hardware and tankage.²⁸ In addition, the compressor stability and compressor-turbine matching problems which arise when injecting water are eliminated in the modern afterburning approach.

In the case of the present system, a significant quantity of sulfuric acid will be stored on the aircraft and ejected into the atmosphere during flight. This liquid could be injected into the engine to provide additional thrust at high altitudes to combat thrust lapse. As discussed in the previous section elevated sulfur content is detrimental to engine component life, and consequently traditional liquid injection techniques (compressor inlet injection) would not be appropriate for this system. However, some thrust augmentation may be realizable by injecting the sulfuric acid downstream of the turbine, in a manner similar to a modern afterburner. By this approach, to achieve thrust increases the turbine exhaust gases must be hot enough to vaporize the sulfuric acid. However, poten-

²⁸ Hall, E. W., and Wilcox, E. C., "Theoretical Comparison of Several Methods of Thrust Augmentation for Turbojet Engines," NACA Technical Report 992, October 1948.

²⁹ Lundin, B. T., "Theoretical Analysis of Various Thrust-Augmentation Cycles for Turbojet Engines," NACA Technical Note 2083, May 1950.

³⁰ Povolny, J. H., Useller, J. W., and Chelko, L. J., "Experimental Investigation of Thrust Augmentation of 4000-Pound-Thrust Axial-Flow-Type Turbojet Engine by Interstage Injection of Water-Alcohol Mixtures in Compressor," NACA Research Memorandum E9K30, April 1950.

tial thrust increases provided by elevated nozzle mass flow will be counteracted by the attendant decrease in total temperature associated with liquid vaporization and heating.

To evaluate potential thrust increases due to sulfuric acid injection the turbofan analysis model was modified to analyze the effects of liquid injection downstream of the turbine. A zero dimensional energy balance approach is employed whereby turbine exhaust gas and injected sulfuric acid were assumed to mix completely in an arbitrarily large control volume, i.e. neglecting fluid/energy transport times. The temperature of the gas mixture exiting the control volume is evaluated based on fluid inlet enthalpies including sulfuric acid heat of vaporization (511 kJ/kg) and fluid heat capacity data. Figure 13 shows the thrust augmentation possible with sulfuric acid injection downstream of the turbine for a PW2040 engine operating at 13.7 km (45 kft). At a sulfuric acid to air mass ratio of 0.086, or a sulfuric acid injection rate of 17 kg/s (37.5 lbm/s), a maximum thrust level of about 35.5 kN (7,946 lbf) is achievable, which is about 1.08 times the engine's base thrust (32.8 kN; 7,370 lbf) at this altitude. At mass ratio greater than this the sulfuric acid only partially vaporizes, and the thrust decreases from the maximum value as a result. It should be noted that the behavior of this plot is highly dependent upon the properties of the injected liquid, particularly its heat of vaporization. For instance, if the liquid is assumed to be water (heat of vaporization = 2258 kJ/kg) the augmented thrust is actually lower than the base thrust for all injected mass flow levels. This is because the drop in gas temperature which results from fully vaporizing the water detracts from the benefit of added mass flow.

As previously mentioned the sulfuric acid release rate range being considered for this study is between 0.003 and 0.1 kg/m. At 13.7 km (45 kft) and a flight Mach number of 0.85 that equates to a sulfuric acid injection mass flow rate range between about 0.73 and 24.9 kg/s. For the PW2040 engine the peak thrust achieved via sulfuric acid injection actually occurs at 17 kg/s per engine (or 0.07 kg/m release rate) which is just over the specified range for a dual engine aircraft. Prior analysis suggests that between 12.2-15.2 km (40-50 kft) the thrust lapse associated with the PW2040 engine is about 4.3 kN/km (300 lbf/kft). Assuming that the engine is installed on a notional aircraft that requires 32.8 kN (7,370 lbf) thrust for steady level flight at 13.7 km (45 kft), and that the 1.08 thrust augmentation ratio is constant with altitude this analysis suggests that sulfuric acid injection could be used to maintain this thrust level up to 14.3 km (47 kft), thereby extending the aircraft's altitude capability by 610 m (2,000 ft).

While the sulfuric acid injection technique described above does provide some extended altitude capability, it does not appear to provide a substantial enough benefit to warrant its implementation in a turbofan engine for that purpose. However, injection of the sulfuric acid into the exhaust in this way may represent an efficient method by which to disperse it into the atmosphere. This analysis suggests that even at the maximum sulfuric acid release rate under consideration (24.9 kg/s) the thrust level produced by the engine is not adversely affected (1.05 thrust ratio).

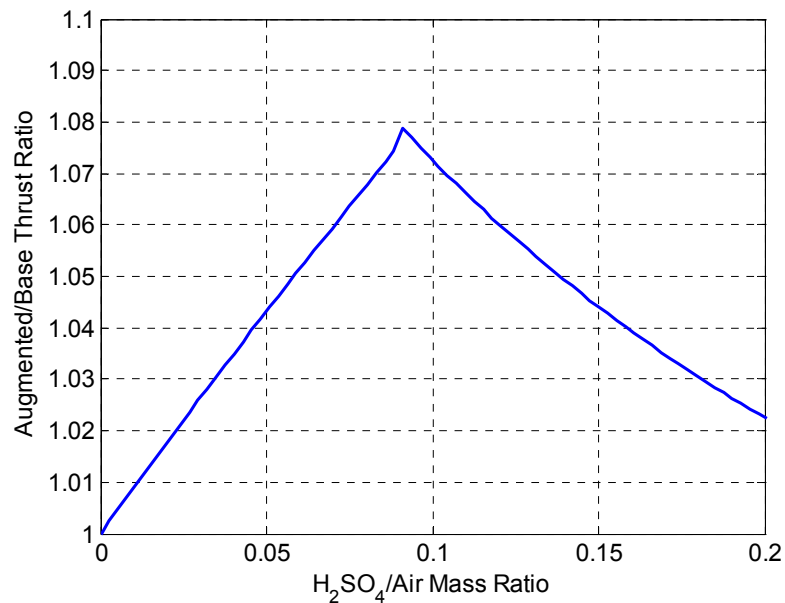

Figure 13: Thrust augmentation possible with sulfuric acid injection aft of turbine for PW2040 engine operating a 13.7 km (45 kft). At H₂SO₄/Air mass ratios greater than 0.086 sulfuric acid does not fully vaporize.

5 Analysis of Existing Aircraft and Results

5.1 Assumptions specific to analysis of existing aircraft

Analysis of existing aircraft focused on estimating the cost of acquiring and operating new or used aircraft. If fleet size represents a large portion of an aircraft's total production, new aircraft price is used to calculate acquisition costs; otherwise a survey of the used market provided typical used acquisition costs. Costs of conversion of existing aircraft for the geoengineering mission are estimated based on costs of converting passenger aircraft to cargo aircraft. For modified versions of existing aircraft, costs of additional engines are included. A summary of acquisition and modification costs is included in Table 5.

Table 5: Acquisition and modification costs used in analysis of existing aircraft costs.

	Boeing 747-400	Boeing F-15	Gulfstream C-37A (Used)	Gulfstream C-37A (New)	Gulfstream C-37A (Modified)	Boeing C-17	Rockwell B-1B
FY10 Acquisition Cost:	\$28,000,000	\$50,000,000	\$22,750,000	\$59,900,000	\$54,900,000	\$240,000,000	\$300,000,000
Notes:	1999 B747-400 ³¹	Estimated	1997 G-V with 5672 total time ³²	New Air-frame Cost	\$5M credit for selling OEM engines.	New cost	New cost
FY10 Modifica- tion Cost:	\$30,459,000	\$5,000,000	\$10,000,000	\$10,000,000	\$20,000,000	\$50,320,000	\$10,000,000
Notes:	USAF Civil Reserve Fleet passenger jet to cargo conversion cost(converted from 1983 \$) ³³	Custom drop tanks with dispenser	Tank installation, dispensers, possible fuel tank modification to carry payload	Tank installation, dispensers, possible fuel tank modification to carry payload	New Engines. Tank installation, dispensers, possible fuel tank modification to carry payload	Four \$11.3M engines plus \$5M for integration.	\$10M For integration of tanks, sprayers, etc.

It should be noted that used aircraft will require more maintenance than a new aircraft. As the aircraft ages, the maintenance burden will increase until the aircraft's usable life has been reached or the economics of keeping the aircraft in service are no longer viable. For this reason, used aircraft may need more frequent replacement than new aircraft placing upward pressure on yearly total costs.

5.2 Choice of Platforms



To limit scope to a manageable number of platforms, five airplane types are down selected and a single aircraft from each type was analyzed in detail. These types allow cost estimates to be extended to a large number of airplanes. For example, while a Gulfstream G550/650 is used to analyze large business jet costs in detail, the cost

³¹ 1999 Boeing 747-400 Aircraft for sale on <http://www.aviatorsale.com> : <http://www.aviatorsale.com/aix6882/>

³² 1997 Gulfstream G-V for sale on <http://www.aviatorsale.com>: <http://www.aviatorsale.com/aix7303/>

³³ Determining the Boeing 747 Conversion Costs for the Civil Reserve Air Fleet Enhancement Program <http://oai.dtic.mil/oai/oai?verb=getRecord&metadataPrefix=html&identifier=ADA134446> Accessed 1/15/2010.

numbers are also representative of most aircraft in this class such as the Dassault Falcon 900 or Bombardier Global 5000.

Type	Representative Airplane	Properties	Availability	
Large Cargo Aircraft	Boeing 747 (-200)	<ul style="list-style-type: none"> • Large cargo capacity • Long range • Efficient 	Dozens available used, approx. 600 built	
High Performance Airlifter	Boeing C-17	<ul style="list-style-type: none"> • Large cargo capacity • Short range • High lift wing 	Available new while production line remains open	
Supersonic Bomber	Rockwell B-1B	<ul style="list-style-type: none"> • Large cargo capacity • Long range • High altitude • Sensitive technology 	Probably not available, 100 built (Russian Tu-160 Blackjacks may be available, 35 built)	
Business Jet	Gulfstream G550/650 (C-37A)	<ul style="list-style-type: none"> • Large cargo capacity OR fuel capacity • Well suited to high altitude 	Available used and new, approx. 190 built	
High Performance Zoom Climber	MacDonnell Douglas F-15	<ul style="list-style-type: none"> • Large Payload • Fast time-to-climb • High Altitude • High maintenance and fuel costs 	Questionable availability, approx. 1200 built. Numerous similar in storage	

5.3 Cost Estimates

5.3.1 Large Cargo Type

Large passenger and cargo transport airplanes are well suited to geoengineering due to their size and affordability but provide limited usefulness due to a lack of high-altitude capability. Regional operations allow the Boeing 747 to operate from 1 or more bases and carry a large payload of 128,000 kg (less than max capacity to allow for better performance at max altitude) per sortie, requiring 47 sorties per day from the fleet. At a release rate of 0.03 kg/m flown, mission lengths are short enough to allow a fleet of 14 747s to execute the 47 sorties a day. By limiting leg length to the 1,600 km required to

hit the preferred dispersal rate, fuel burn is kept to 0.016 kg/m per aircraft. Altitude is limited to 13.7 km (45kft). Costs are as follows:

- Aircraft Acquisition Cost: \$0.8 Billion FY10 USD
- Yearly Operations cost: \$1.0 Billion FY10 USD
- Yearly Total Cost (including depreciation and interest): \$1.1 Billion FY10 USD

5.3.2 High Performance Airlifter Type

The high performance airlifter type in stock configuration is similar to the large cargo type, so it is only analyzed with modifications to extend its maximum altitude. Details are discussed in section 5.4.2.

5.3.3 Supersonic Dispersal (Supersonic Bomber Type)

Supersonic high altitude bombers are examined for completeness, though there are significant challenges associated with employing this type of aircraft for geoengineering. While their high speed makes them ideal for transit CONOPs and they have large payloads, issues include creating sonic booms over land, appearing as an aggressor when entering airspace, and the expense and sensitivity of their technology.

The Rockwell B-1B has an altitude capability in excess of 18.3 km (60kft). When operating from 4 bases and flying transit legs between the bases, payload is 60,000 kg. A fleet of 28 aircraft are required, conducting 45 sorties a day. Release rates, driven down by the leg length between bases, are 0.01 kg/m flown. Fuel burn is 0.0025 kg/m flown. The availability of this type of aircraft is questionable. While 100 B-1s were built; it is not likely the US Government would sell them. Russian Tu-160 may be available for purchase, or potentially either aircraft could be put back into limited production. With no second hand market, the new aircraft cost is used for acquisition cost estimates. Costs are high:

- New Aircraft Acquisition Cost: \$8.7 Billion FY10 USD
- Yearly Operations cost: \$3.6 Billion FY10 USD
- Yearly Total Cost (including depreciation and interest): \$4.7 Billion FY10 USD

5.3.4 Business Jet Type

Business jets are designed for higher altitude flight above commercial aircraft traffic but are expensive to purchase and operate. Their large fuel capacity for long range flight allows them to carry large volumes of geoengineering payload when flying short duration missions. The Gulfstream G550/650 can operate regionally from 1 or more bases and carry 16,300 kg of payload per sortie, requiring 168 sorties per day. At a release rate of 0.04 kg/m flown, mission duration is short requiring a fleet of 66 aircraft. Busi-

ness jets are efficient, fuel burn is 0.0014 kg/m flown. Altitude is limited to 15.5 km (51kft). Costs are as follows:

- New Aircraft Acquisition Cost: \$2.1 Billion FY10 USD
- Yearly Operations cost: \$2.1 Billion FY10 USD
- Yearly Total Cost (including depreciation and interest): \$2.4 Billion FY10 USD

5.3.5 High performance Zoom Climber Type

Large numbers of small, high-performance interceptor aircraft have been built and are in service around the world. Many U.S. aircraft are in storage at Davis-Montham Air Force Base but the availability and flight-readiness of these airframes is unknown. Still, with many older aircraft being sold to other nations and new aircraft constantly coming online to replace old ones, the availability of aircraft such as the F-15, F-4, F-111, and F-14s is good. The Boeing F-15 has an altitude capability estimated at 25.9 km (85k ft) in a zoom climb. Carrying a payload of 4,000 kg and minimal fuel load to reduce weight, 671 sorties per day are required. Due to the high performance of this aircraft type the entire sortie takes only 23 minutes requiring a fleet of 133 aircraft. At altitude, a 3 minute supersonic cruise leg allows the F-15 to deploy the particulate at a rate of 0.037 kg/m flown. Climb performance requires the use of afterburners so fuel burn is 0.025 kg/m flown. Cost of a used high performance interceptor is difficult to determine, a value of \$55M per aircraft is used in cost calculations. These aircraft are also maintenance intensive. Costs are as follows:

- Used Aircraft Acquisition Cost: \$7 Billion FY10 USD
- Yearly Operations cost: \$7.6 Billion FY10 USD
- Yearly Total Cost (including dep. and int.): \$8.4 Billion FY10 USD

5.4 Modifications to Existing Aircraft

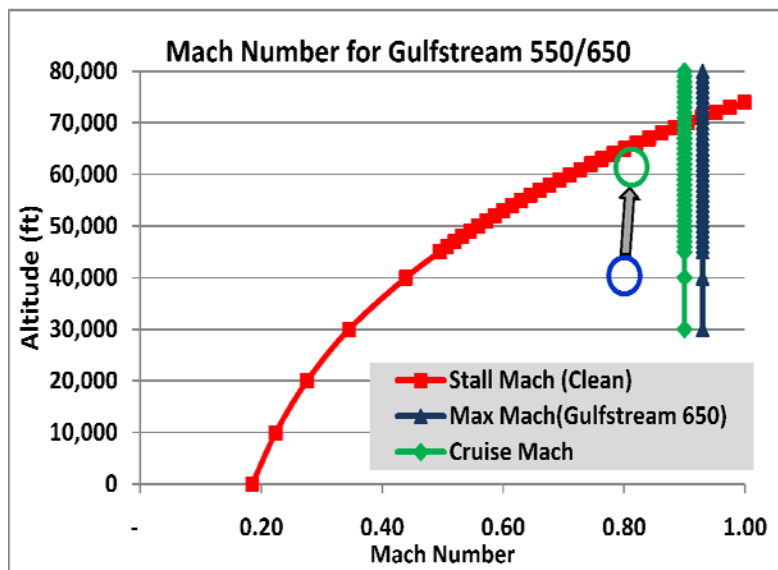

Figure 14: Mach number capability for the Gulfstream G550/650. The typical cruise condition of Mach 0.8 at 40,000 ft is shown by the blue circle. Aerodynamically, altitude can be increased to 60,000 ft.

As discussed in section 4.2, propulsion for high altitude aircraft is a challenge. While most aircraft surveyed have aerodynamic capability for additional altitude, thrust lapse of their engines limits the thrust availa-

ble to them at higher altitudes preventing them from flying higher.

5.4.1 BizJet Class

The Gulfstream G550/650 is designed for fast flight, close to the speed of sound, at altitudes of up to 15.5 km (51kft). As shown in Figure 14 the G550/650s coffin corner is at about 19.8 km (65kft). Operating at this altitude requires the aircraft to fly at a high lift coefficient to generate enough lift to sustain altitude. This causes the aircraft to be less efficient due to increased induced drag requiring more thrust.

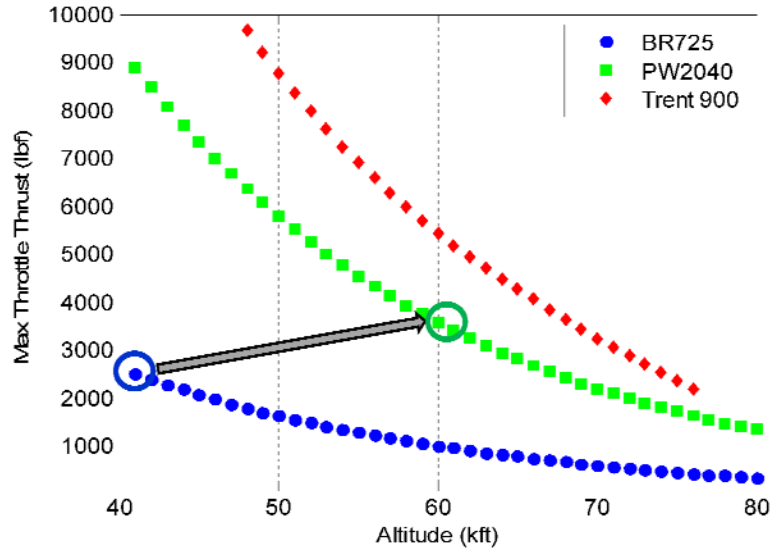

Figure 15: The Gulfstream G550/650’s two Rolls-Royce BR725 engines produce the 2,500 lb of thrust each required to maintain speed at 40,000 ft. When altitude is increased to 60,000 ft over 3,100 lb thrust is required to maintain speed (the aircraft is less efficient aerodynamically at this altitude). The BR725s produce only 1,000 lb thrust at 60,000 due to thrust lapse.

The thrust available from the G550/650’s Rolls-Royce BR725 engines at 12.1 km (40kft) is about 20% of the sea level thrust of the engines. As altitude is increased thrust laps reduces the available thrust from the BR725s to <10% of the sea level thrust (Figure 15). Thus significantly larger or more powerful engines are required. Table 6 illustrates the propulsion requirements at several operating points.

Table 6: Gulfstream G550/650 re-engining comparison

	Gulfstream Initial Cruise (41kft)	Gulfstream Final Cruise (51kft)	Extended Altitude (60kft)
Lift Coefficient	0.44	0.47	1.25
Drag Coefficient	0.024	0.026	0.08
L/D	18.4	18.4	14
Thrust Required (lb)	4,800	3,200	6200
Available Thrust (lb)	5,000	3,400	2000

A large high bypass ratio turbo fan engine is one possible choice for re-engining of the G550/650 (see Table 7). The efficiency of a high bypass engine, such as the Pratt & Whitney PW2040 used on the C-17 and Boeing 757) makes it desirable from a fuel burn

stand point, but its large diameter and weight make the feasibility of this option questionable. It is more desirable to choose a low bypass engine that exhibits less thrust lapse with altitude. A survey of potential engines was conducted and no low bypass engines produced enough thrust at altitude without the use of an afterburner. While the selected Pratt & Whitney F100 is similar in weight to the original BR725, the high fuel consumption of the afterburning engine reduces payload of the G550/650.

Table 7: Potential re-engining options for the Gulfstream G550/650

The G550/650 fitted with F100 engines can deliver 13,600 kg of payload to 18.2 km (60kft). A total of 43 aircraft are required to operate 200 sorties per day. A release rate of 0.034 kg/m flown is achieved while fuel burn is 0.004 kg/m flown, almost 4 times that of the original G550/650. Costs, including cost of new engines, are as follows:

- New Aircraft Acquisition Cost: \$3.2 Billion FY10 USD
- Yearly Operations cost: \$2.5 Billion FY10 USD
- Yearly Total Cost (including depreciation and interest): \$2.7 Billion FY10

5.4.2 High Performance Airlifter Type

Military airlifters appear to be promising geoengineering aircraft due to their large cargo capacity and high lift aerodynamics designed to allow them to takeoff from short run-

ways. Analysis of the Boeing C-17 showed that altitude capability is limited by engine thrust (

Figure 16) which drops by 50% as altitude is increased from 13.7 km (45kft) to 18.2 km (60kft).

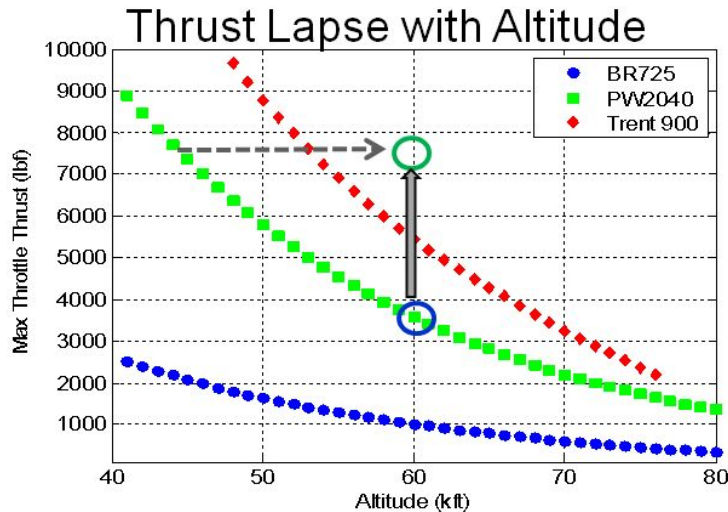

Figure 16: The Boeing C-17 requires about 7,500 lb of thrust from each engine at cruise. When increasing altitude (along black dashed line) to 60,000 ft, thrust available from each PW2040 engine drops to 3,500 lbs (blue circle). A doubling of available thrust (green circle) is required to maintain altitude at 60,000 ft.

Adding four more engines, notionally PW2040s or a lower bypass engine, provides the C-17 with enough thrust to achieve an altitude of 18.2 km (60kft). Op-

erating regionally on short duration missions, payload is 45,000 kg requiring 60 sorties per day performed by a fleet of 24 aircraft. The short range of the C-17 combined with the additional fuel consumption of the 8-engine drives release rates to 0.06 kg/m flown, while fuel burn is 0.025 kg/m flown. Costs, including acquisition and integration costs of additional engines are:

- New Aircraft Acquisition Cost: \$7.0 B
- Yearly Operations cost: \$2.8 Billion
- Yearly Total Cost (including depreciation and interest): \$3.6 Billion FY10

5.5 Conclusions

Existing Systems are optimized to transport a payload quickly and efficiency over a long distance. They are not optimized for high altitude flight and therefore are poorly suited to the geoengineering mission. Operating existing aircraft at their ceiling, or beyond with expensive modifications, requires lightly loading them driving fleet size up. The small zoom climber type does have high altitude capability, but its size drives fleet size well over 100 aircraft and their fuel consumption makes operations costs the highest of all airplane options examined. Supersonic bomber aircraft provides the payload and altitude capability required for geoengineering but the feasibility of acquiring and operating them is questionable and costs are high.

Costs grow rapidly as altitude is increased. The yearly cost (including operations, depreciation, and interest) of regional CONOPs increases by \$0.85B for every 1.5 km (5,000 ft) increase in altitude (Figure 17). This means moving from the 12.1 km (40kft) operating altitude of most commercial airliners, to 19.8 km (65kft) represents an increase in yearly cost of \$4.25B.

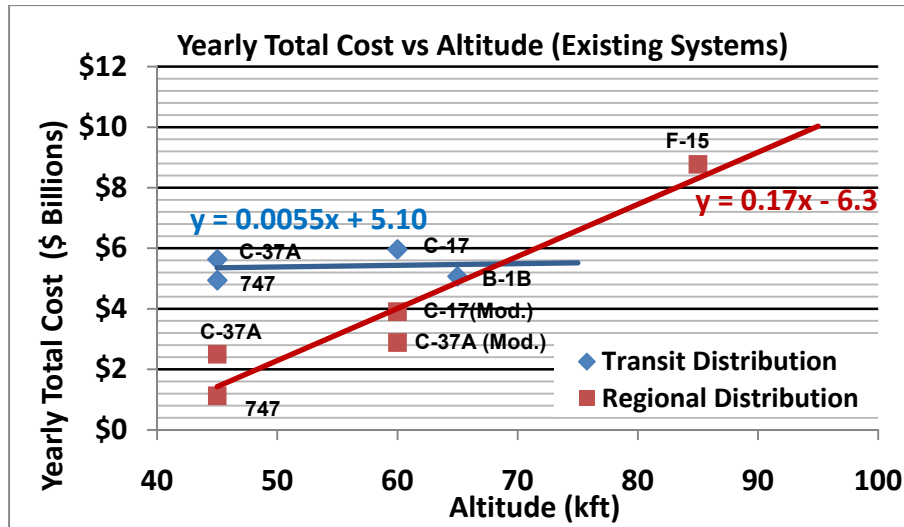

Figure 17: Plot of yearly total cost (operations, depreciation, and interest) for the existing aircraft systems examined.

A summary of all the existing systems examined is included below in Table 8:

Table 8: Summary of Fleet, Operations, and Yearly costs for all existing systems

Description	Altitude (kft)	Development and Acquisition Costs (\$B)	Total Ops Cost (\$B)	Yearly Total Cost (Including Dep. and Int.)	Dispersion
Boeing 747-400 Class	45	\$0.82	\$1.00	\$1.13	Regional
Gulfstream C-37A Class	45	\$2.16	\$2.15	\$2.50	Regional
Modified Gulfstream C-37A	60	\$3.23	\$2.37	\$2.89	Regional
Modified Boeing C-17	60	\$6.97	\$2.79	\$3.91	Regional
Boeing F-15 Class	85	\$7.32	\$7.60	\$8.77	Regional
747-400 Class	45	\$2.81	\$4.49	\$4.94	Transit
Gulfstream C-37A Class	45	\$8.39	\$4.28	\$5.63	Transit
Modified Gulfstream C-37A Class	60	\$7.77	\$4.71	\$5.96	Transit
Rockwell B-1B	65	\$8.68	\$3.68	\$5.07	Transit

The cost breakdown for the various systems varied depending on the type. For most types, personnel costs dominated operations costs. The high maintenance zoom

climber support personnel costs are almost 50% of operations costs. The large cargo transports high gross weight drives flight crew costs up, accounting for 35% of operations costs. The high fly-away cost of the Gulfstream G550/650 drives up the price of spare parts, causing them to account for 30% of operations costs. The breakdown of costs for each system is included below in Table 9.

Table 9: Breakdown of yearly operations an, depreciation, and itnerest costs

Description	Support Personnel Costs (\$B)	Fuel Costs (\$B)	Spares Cost (\$B)	Flight Crew Costs (\$B)	Total Yearly Ops Cost (\$B)	Depreciation and Interest Cost (\$B)	Yearly Total Cost (Including Dep. and Int.) (\$B)
Boeing 747-400 Class, Regional	\$0.19	\$0.40	\$0.28	\$0.18	\$1.00	\$0.13	\$1.13
Gulfstream C-37A Class, Regional	\$0.56	\$0.19	\$0.73	\$0.95	\$2.15	\$0.35	\$2.50
Modified Gulfstream C-37A, Regional	\$0.21	\$0.10	\$0.80	\$1.04	\$2.37	\$0.52	\$2.89
Modified Boeing C-17, Regional	\$0.34	\$0.91	\$1.38	\$0.23	\$2.79	\$1.12	\$3.91
Boeing F-15 Class, Regional	\$4.57	\$1.07	\$1.04	\$1.66	\$7.60	\$1.18	\$8.77
747-400 Class, Transit	\$0.79	\$2.16	\$1.41	\$0.18	\$4.49	\$0.45	\$4.94
Gulfstream C-37A Class, Transit	\$1.14	\$0.54	\$1.91	\$0.96	\$4.28	\$1.35	\$5.63
Modified Gulfstream C-37A Class, Transit	\$0.44	\$0.27	\$2.10	\$1.06	\$4.71	\$1.25	\$5.96
Rockwell B-1B, Transit	\$0.43	\$0.37	\$2.75	\$0.17	\$3.68	\$1.40	\$5.07

Existing aircraft offer a cost-effective way to begin a geoengineering campaign for minimal upfront costs, but there are trade-offs to employing used aircraft. The aging aircraft require increasing maintenance, driving up operations costs the longer they remain in service. It is unlikely a used aircraft will be safe and economical to operate for a 20-year geoengineering effort. The cost impact of more frequent aircraft replacement is shown in Figure 18 below.

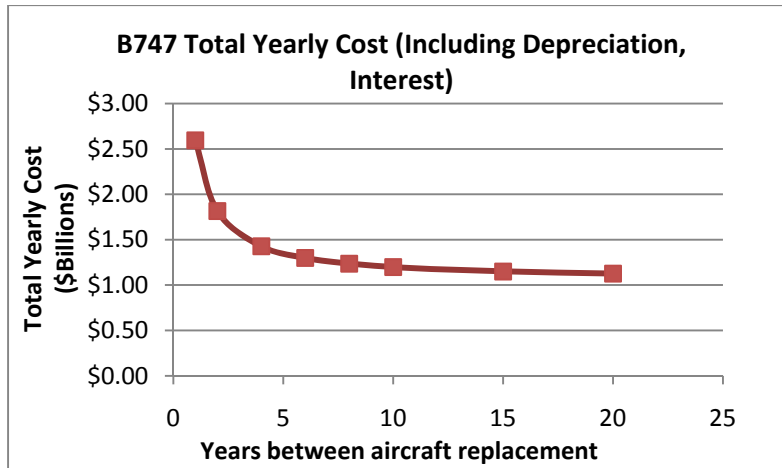

Figure 18: Used aircraft may have diminished useful life remaining. The impact of more frequent aircraft replacement on total yearly cost is shown above.

6 New Aircraft Design

The analysis of new aircraft designs for the geoengineering mission was an in depth look at what design would be the most affordable for geoengineering operations. Typically an aircraft is designed for a particular mission, and is optimized for a primary operating point, such as cruise for a commercial transport. Dozens of aircraft design parameters are fine tuned to optimize the aircraft for the mission. These translate to an infinite spectrum of aircraft designs for a given operating point, each with specific RDT&E, acquisition, and operations costs. These design parameters are interdependent and must be carefully balanced to obtain a design that closes and fulfils the mission.

To examine the design spectrum for geoengineering, Aurora Flight Sciences utilized an in-house aircraft design and sizing code originally developed to look at high efficiency transport aircraft. This code was integrated with the CERs presented in section 3.1 and driven by a parametric analysis software package called iSight (Figure 19).

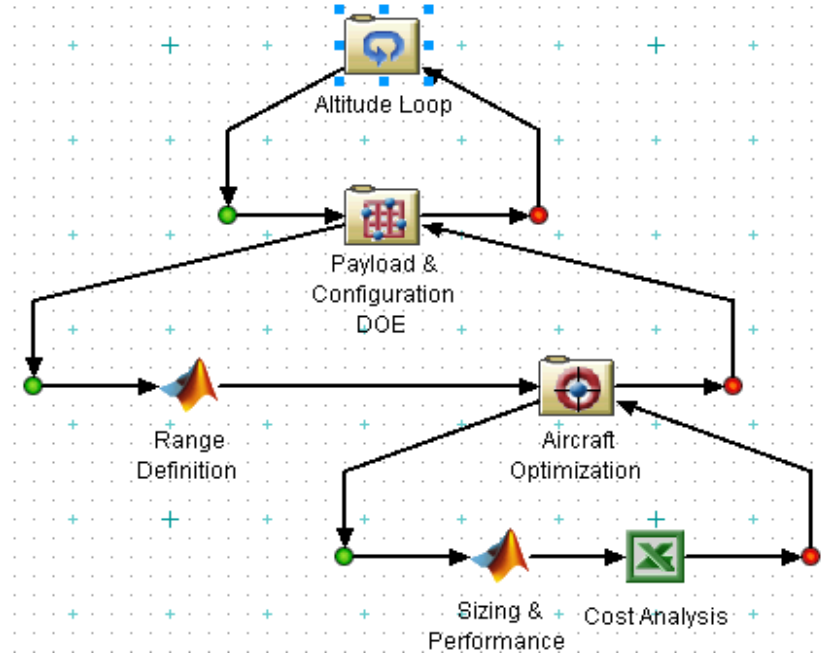

Figure 19: iSight Optimizer design, including a top level Altitude Loop with a nested Design Of Experiments block (DOE) to vary aircraft input parameters. The specific mission, based on payload and release rate is determined by a Matlab Range Definition script which feeds the mission profile into an Aircraft Optimizer. The optimizer fine tunes the aircraft to find a closed design, then passes inputs to an Excel based Cost Analysis tool.

A top level loop in iSight steps through 6 altitudes, calling a Design of Experiment (DOE) that steps through 32 combinations of airplane payload, propulsion type, and number of engines. The range of each input is included below (Table 10).

Table 10: Exploration variable inputs to iSight DOE

Exploration Variable	Lower Limit	Upper Limit
Altitude	40,000 ft	100,000 ft
Payload	10,000 kg	100,000 kg
Number of Engines	2	8
Propulsion System	Propeller	Turbofan

A Matlab script is used to determine the mission profile for each set of inputs. Cruise altitude dictated time-to-climb and time-to-descend. Payload mass dictated range based on the requirement to release payload at 0.03 kg/m flown. With the mission defined, the aircraft optimizer utilized a genetic algorithm to design a spectrum of aircraft for each combination of inputs. A total of 1,200 designs are examined for each altitude and combination of inputs. Parameters including wingspan, wing aspect-ratio, wing

thickness, wing sweep, thrust-to-weight ratio, fuel fraction, payload fraction, cruise speed are varied. This translates to a design space of over 230,400 individual aircraft designs (6x32x1200). This analysis was run for 3 yearly up-masses, 1M tonnes, 3M tonnes, and 5M tonnes. Designs that violated the range requirements or lacked the excess power to climb to altitude in a reasonable amount of time are discarded. A total of over 300 airplane configurations successfully closed and completed the mission at various altitudes for varying costs. These airplane configurations are then ranked by cost.

6.1 New Aircraft Assumptions

The analysis of new aircraft platforms assumed a 20-year aircraft design life, consisting of approximately 7,000 flight hours per year or about 2,000 cycles. This is comparable to a Boeing 737 with a design life of about 150,000 hours and 75,000 cycles. Aircraft designs are optimized by depreciating acquisition costs over this 20-year life.

6.2 Uncertainty Analysis

An uncertainty analysis was performed on aircraft costs estimates. The following ranges of uncertainty are established for the inputs to the CERs. These uncertainties are based on engineering judgment and historic trends for aircraft cost prediction in the conceptual design phase.

Table 11: Acquisition/RDT&E uncertainties (top) and operations uncertainties (bottom)

Uncertainty in CER Inputs (Acquisition)		
W_{empty}	+/-	10%
V_{max} (fps)	+/-	20
M_{max}	+/-	0.05
Turbine Inlet Temp (deg R)	+/-	100
Thrust (lb)	+/-	1000
Number Produced	+/-	10%

Uncertainty in CER Inputs (Operations)		
Block Time (min)	+/-	40
Takeoff Weight	+/-	10%
Fuel Cost (\$)	+/-	0.06
Block Radius (Nmi)	+/-	305
Flight Speed (knots)	+/-	12
Block Speed (knots)	+/-	12

MMH/FM	+/-	50%
--------	-----	-----

6.3 Cost Estimates

Airplane RDT&E and acquisition costs as well as upper and lower uncertainty bounds are shown in the following plots (Figure 20) for 1M, 3M, and 5M tonnes. The optimized aircraft design is similar to that of a Gulfstream G200, so that aircraft was used to compare acquisition costs. It is apparent that engine costs above 19.8 km (65kft) increase RDT&E and acquisition costs significantly.

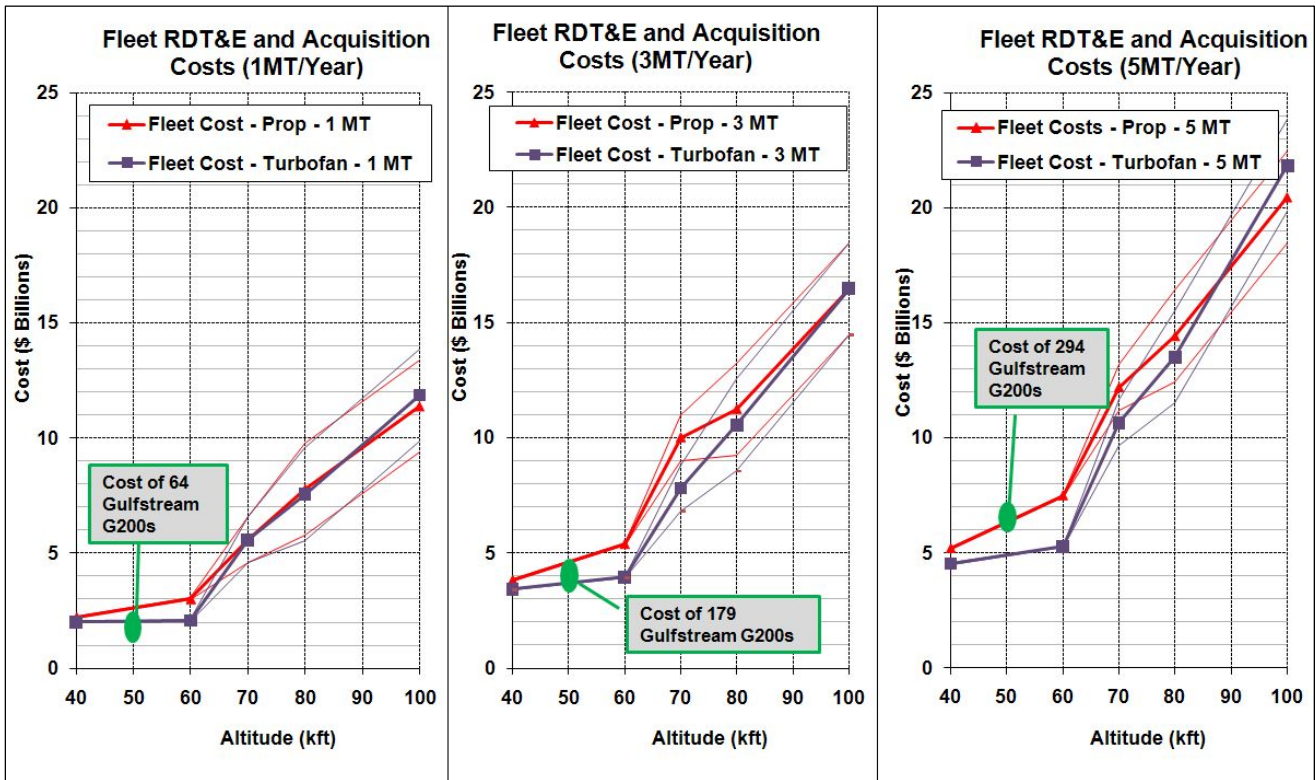

Figure 20: New-design airplane RDT&E and Acquisition cost estimates for 1M, 3M, and 5M tonnes per year up-mass. The upper and lower uncertainty bounds shown with fine lines.

Operations costs are plotted Figure 21 for 1M, 3M, and 5M tonnes along with upper and lower uncertainty bounds. As expected, operations costs grow rapidly above 19.8 km (65kft) altitude. This is due to the use of more expensive, exotic fuels at high altitude as well as larger fleets due to the longer missions extended due to slower cruise speeds and longer climb legs. Operations costs are compared to several airlines, with costs scaled by yearly tonne-kilometers flown.

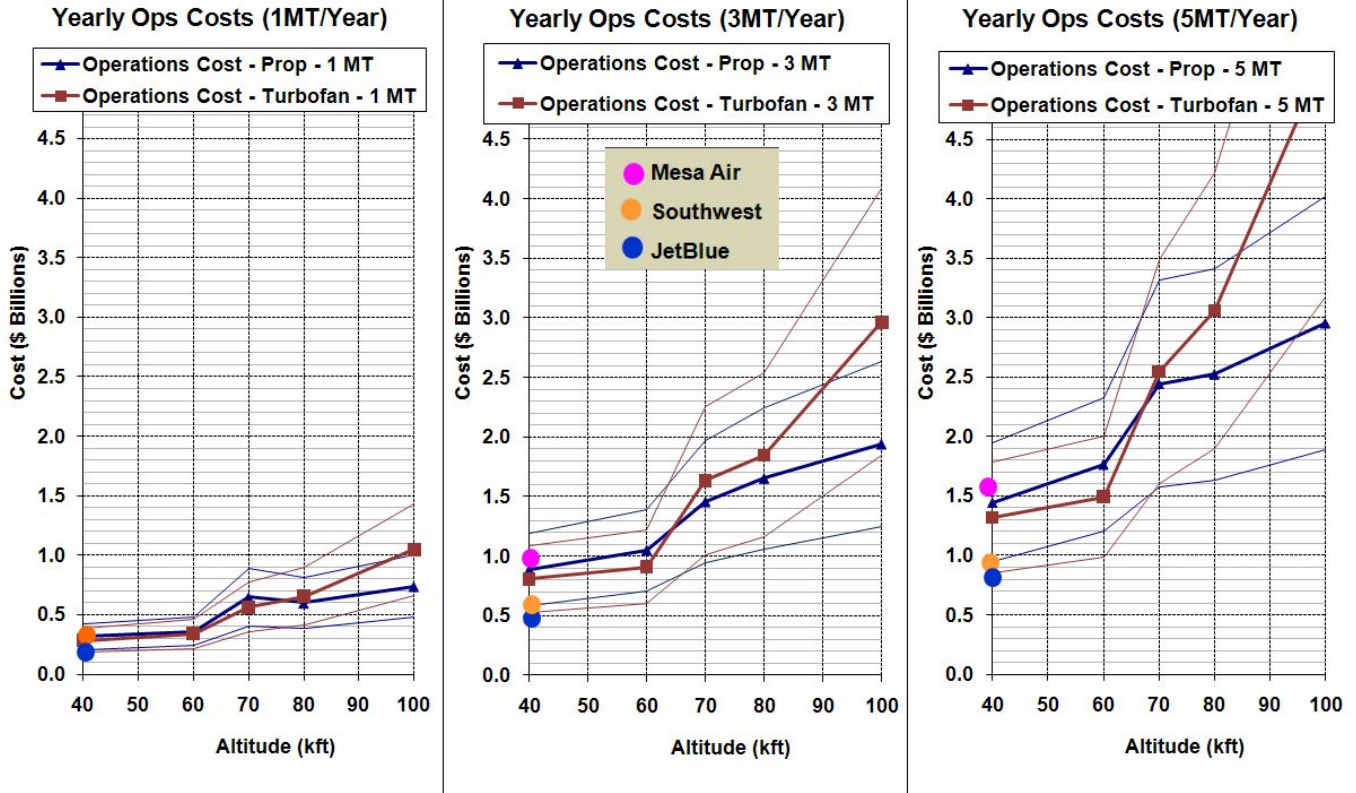

Figure 21: Yearly operations costs for 1M, 3M, and 5M tonnes yearly up-mass. Costs are compared against FY08 or FY09 operating expenses for several airlines. Expenses are scaled by yearly tonne-kilometers flown. Personnel costs for comparables are scaled by 2/3 to account for flight attendant, booking, and customer service personnel.

Combining depreciation and interest for the RDT&E and acquisition costs with yearly operations cost, a yearly total cost can be determined. This yearly cost is plotted vs. altitude in Figure 22. Uncertainty is included as are the second lowest cost airplane designs. There is a noticeable increase in cost above 19.8 km (65kft) due to the increase in engine development costs and fuel costs.

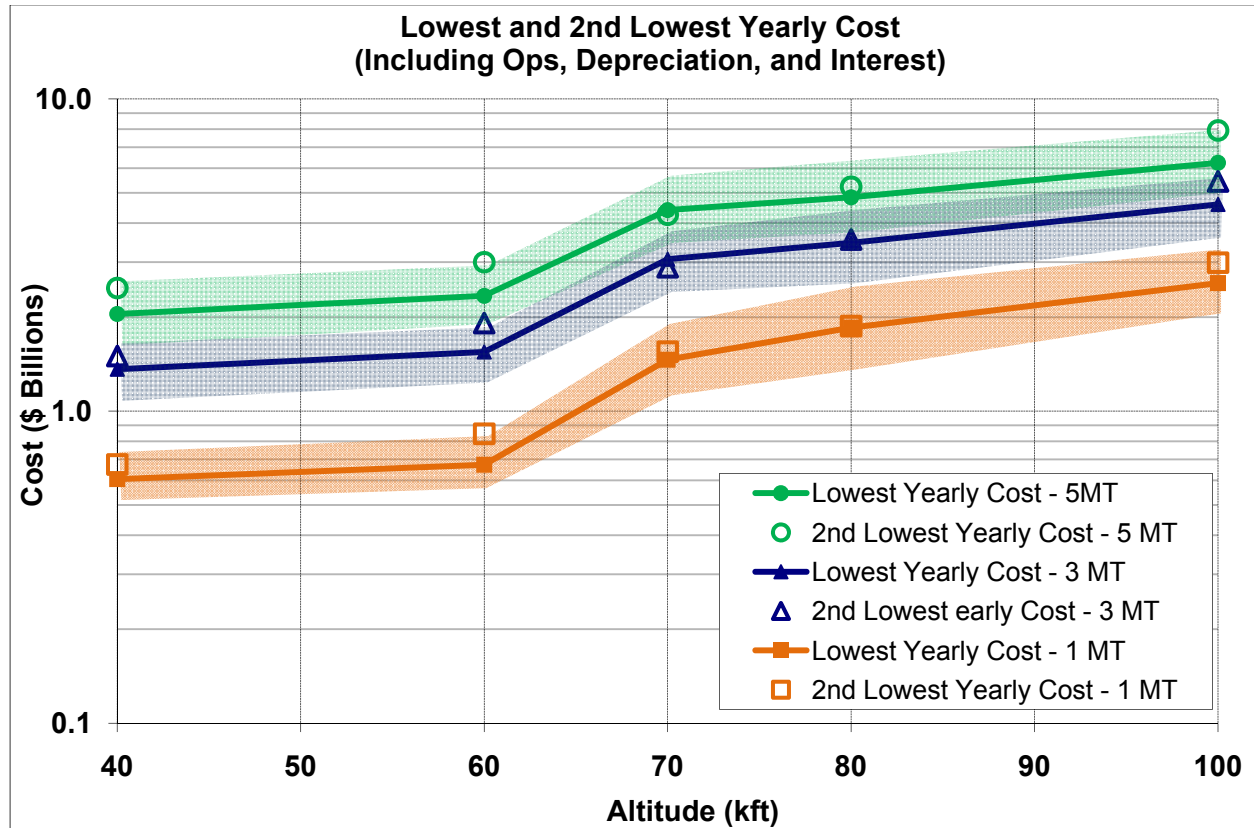
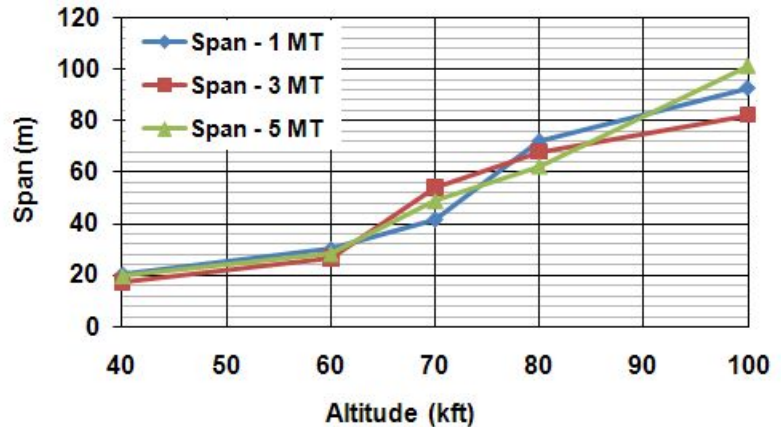

Figure 22: New-design yearly cost including depreciation, interests (both over 20-years), and yearly operations costs. Lowest cost design is plotted with uncertainty, with second lowest cost design shown with open symbols.

6.4 Conclusions

As expected, both operations and acquisition costs are minimized by flying smaller, lighter planes. For almost all altitudes, and yearly up-masses, a 10,000 kg payload size is the most affordable. This is logical as a larger payload vehicle requires a larger air frame utilizing more materials; requires more powerful engines which are more costly; and requires a more highly trained crew that is paid more. The only missions that benefit from a larger payload mass is low altitude operations at 18.2km and 21.3km (60kft, 70kft) when yearly mass is 5M tonnes. In these 2 cases, due to the large fleet required for 5M tonnes per year, a 40,000 kg payload is more cost effective. At higher altitude, the large wing span required to lift the larger aircraft as well as the propulsion requirements drove payload mass down to 10,000 kg.

Figure 23: New design airplane optimized wing span vs. altitude. As expected, wing span increases with altitude due to decreasing atmospheric density.



As expected, airplane wing span increased with altitude due to the reduction in air density with altitude. A plot of airplane wing span vs. dispersal altitude is included in Figure 23.

The optimized aircraft have cruise lift coefficients of 0.6 to 1.1. Due to the slow cruise speed, wing sweep is between 10° and 20°. Not surprisingly at lower altitudes, the geoengineering airplane optimizes out to be very similar to a business jet, but with less wing sweep due to slower cruise speed and lower price due to the lack of executive interior furnishings.

	Geoengineering Aircraft (15.2 km / 50 kft)	Gulfstream G250 (13.7 km / 45 kft ceiling)
Gross Weight (kg)	14,000	16,000
Wing Span (m)	20	17.7
Wing Sweep	10°	28°
Civil Purchase Cost ³⁴ (each)	\$16M	\$21.5M

At higher altitudes, the optimized geoengineering aircraft begins to resemble other high altitude aircraft. At about 20 km (65kft) the wing span is about 35 meters, comparable to the 32m wing span of the Lockheed U-2 designed to fly at over 20 km.

The optimized designs favor 2 engines over greater numbers as engines are a large contributor to RDT&E and acquisition costs as well as spare parts costs. At 30.5 km (100kft) the effect of thrust lapse is great, driving the number of engines required to 4.

Fleet size is heavily dependent on altitude as well as yearly up-mass. As altitude is increased, aircraft are pushed to the limit to generate adequate thrust to attain cruise altitude. Time to climb increases dramatically. Similarly, as coffin corner shrinks the acceptable speed range for the aircraft, they must fly slower to avoid formation of shocks. These two factors drive mission time from just over an hour at 12.2 km (40kft) to over 3 hours at 30.5 km (100kft). Longer missions reduce the number of sorties each aircraft

³⁴ Civil Purchase Cost refers to the cost a single aircraft including cost of production and production tools as well as RDT&E costs.

can perform driving up fleet size. Figure 24 shows the trend in fleet size with altitude for a variety of yearly up-masses.

Figure 24: Fleet size as a function of altitude for 1M, 3M and 5M tonnes per year.

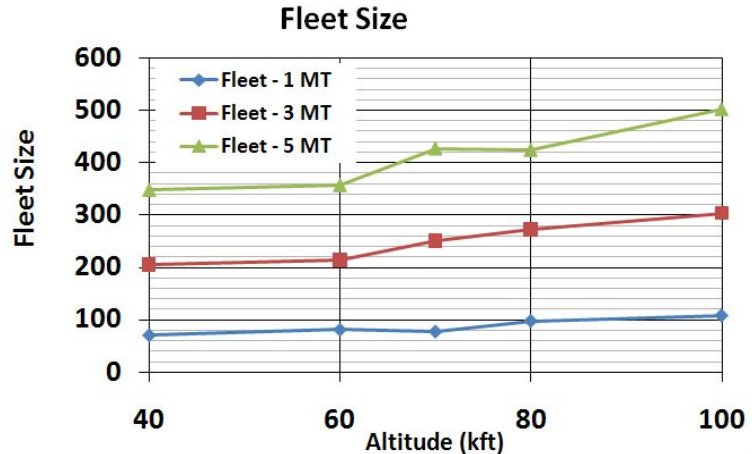

7 Airships

7.1 Airship Design Considerations and Assumptions

Airships provide an attractive solution to the mission of payload delivery because of their large payload capacity and long endurance potential. The idea of using airships for heavy payload missions resurfaces from time to time as technology develops and economic shocks cause a reexamination of current modes. For over 100 years, Lighter Than Air (LTA) vehicles have provided persistent mission capability for operations where speed was not a driver. LTA's, or blimps, are used in low altitude tourist operations in several locations around the world and are regularly employed as camera platforms over sporting events where their persistence and fuel efficiency is unmatched by rotary or fixed wing systems. In recent years the concept of Hybrid Lift Airships (HLA) has emerged as a way to reduce vehicle size and improve ground handling. HLA's generate the majority of their lift from buoyant forces like conventional LTA's but generate a small percentage dynamically due to aerodynamic forces like a conventional airplane. This affords HLAs the opportunity to be net heavy on the ground making operations simpler and safer.

The HLA technology shows promise for geoengineering operations, but the technology is still in its infancy. Several companies, such as Northrop Grumman and Lockheed Martin, have developed technology demonstrators that are intended to prove the theory of HLA design with goals of operating them at 65,000 ft or higher. However, current development programs focus on much lower altitudes. A recent U.S. Army contract will provide Northrop Grumman with up to \$517 million for development of a football field-sized HLA capable of operating at 20,000 ft.³⁵

³⁵ "Long Endurance Multi-Intelligence Vehicle (LEMV) Agreement Signed." Jun 17, 2010. Online Posting. www.army.mil. Oct 25, 2010 <<http://www.army.mil/-news/2010/06/17/41024-long-endurance-multi-intelligence-vehicle-lemv-agreement-signed/>>

The Lockheed Martin P-791 prototype, developed with \$100M in funding from the U.S. Department of Defense and significant investment from Lockheed, generates as much as 20 percent of its lift from dynamic forces (known as percent heaviness) (Figure 25). Despite several flights proving the technology, Lockheed has not flown the P-791 at high altitude and, with its cruise speed of 20 kts, it most likely lacks the power required to overcome high altitude winds. Significant development is still required to increase the speed (to navigate winds aloft), payload capacity, and altitude capability of HLAs.



Figure 25: Lockheed Martin's HLA technology demonstrator that made its first flight in 2006³⁶ Hybrid Airship Design

LTA design has many established and understood design practices but HLA design presents new and previously unexplored challenges. For this study, many design considerations are taken from "Conceptual Design of a Hybrid Lift Airship for Intra-regional Flexible Access Transport"³⁷.

Key Assumptions

- A turboprop engine model is used for propulsion analysis. Costs of developing or modifying engines are computed using a modified version of the engine CER presented in section 3.1
- The Hull material and construction are sophisticated enough to handle a positive pressure differential without deformation.
- Ballonets that can take 50% of the volume of the HLA with only 1% He loss per flight

7.1.1 HLA Model

A Matlab model is used to design and simulate individual airships. The diagram of this model can be seen in Figure 26. The model is used to analyze airships going to 15, 20, 25 and 30 kilometers maximum altitude with 0, 10 and 20 percent heaviness.

³⁶ Lockheed Martin flight test video: <http://www.youtube.com/watch?v=wUkCyXCqUx8>

³⁷ Agte, J., Gan, T., Kunzi, F., March, A., Sato, S., Suarez, B., Yutko, B., "Conceptual Design of a Hybrid Lift Airship for Intra-regional Flexible Access Transport," AIAA Paper 2010-1391, 48th AIAA Aerospace Sciences Meeting, Orlando, FL, 4-7 January, 2010.

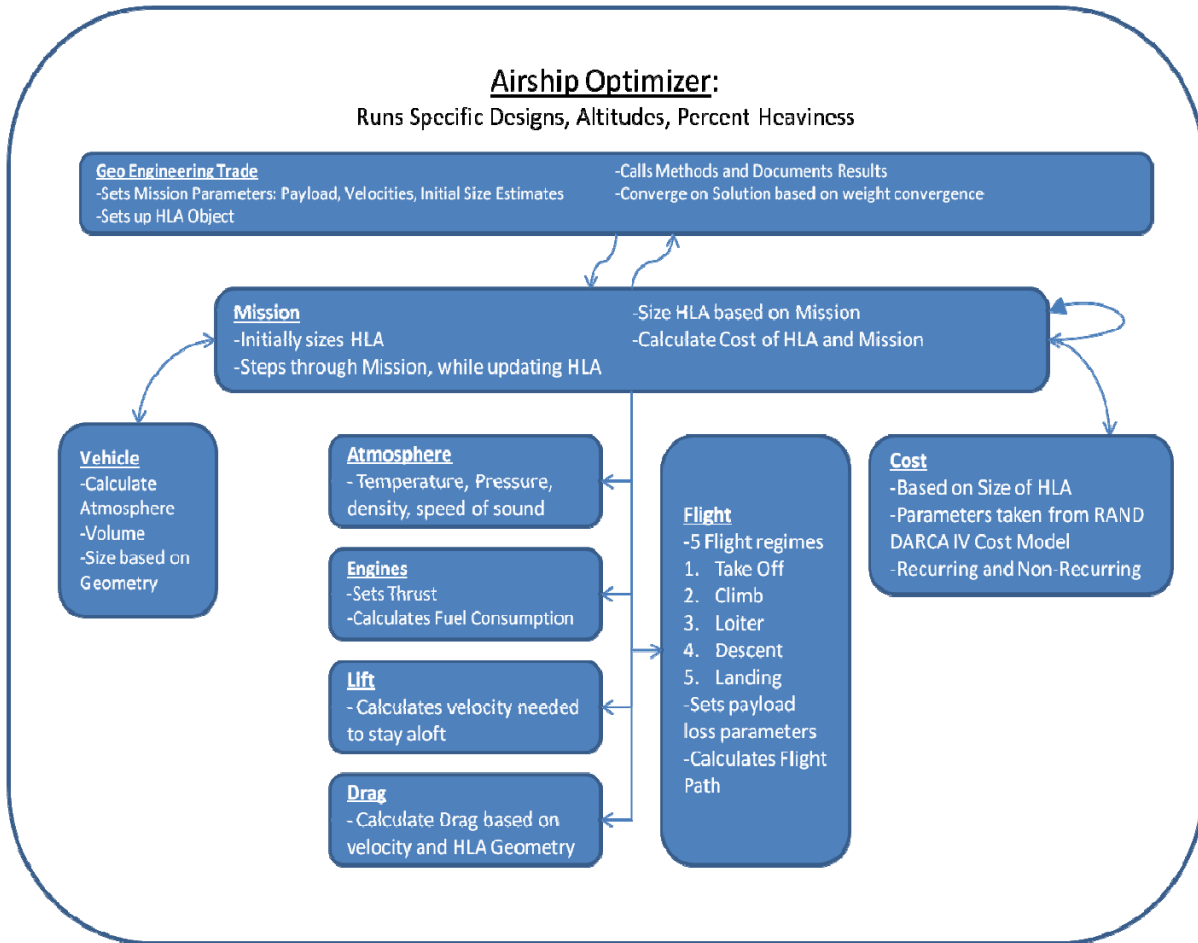

Figure 26: Matlab model used to optimize HLA size and simulate missions

Vehicle Sizing

Without high fidelity aerodynamic modeling, sizing a novel vehicle of this size remains uncertain. For the purposes of this study, a very simple design is considered and kept constant across vehicles. A volume of helium is calculated based on percent heaviness and the amount of helium needed to lift the vehicle at maximum altitude, the remaining equations can be seen in appendix 10.2. Figure 27 shows the conceptual design of an intra-regional HLA transport that could carry 45 metric tons across the continental US. The model used the idea of connecting hulls to widen the vehicle and thus increase its aerodynamic performance.

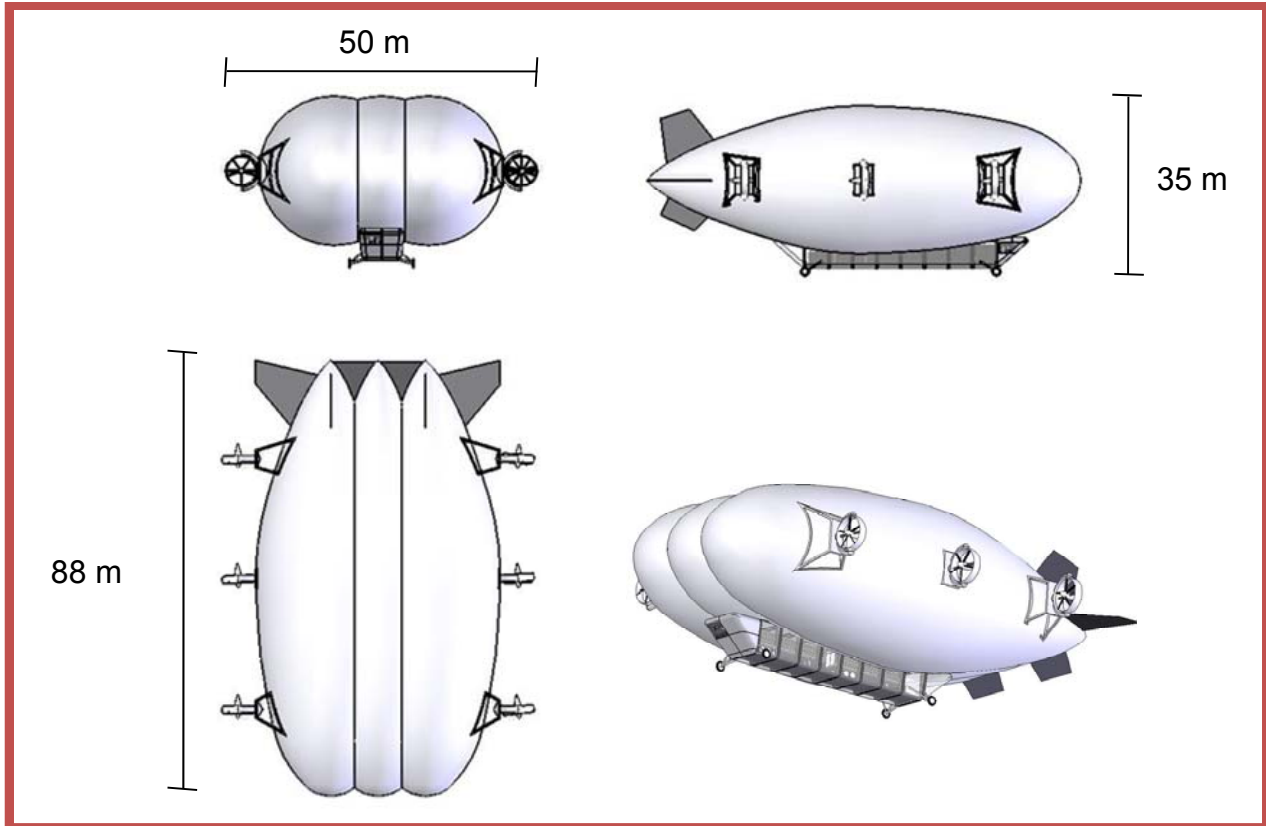

Figure 27: Conceptual design of a HLA that could carry 45 metric tonnes in intra-regional cargo transport.

Aerodynamic Forces

This study uses a low fidelity aerodynamic model based on basic principle and engineering estimates. As a result, many forces are allowed to vary to achieve steady level flight and are then evaluated in a post process step to ensure validity.

Buoyancy Management

One open issue surrounding a HLA's with enormous lifting capability is recovering the vehicle after it has released its payload. In a conventional airship, ballonets are used to maintain equilibrium pressure across the hull surface so that by controlling the flow of air into the ballonets, net buoyancy can be controlled. The vehicles in this study are not only carrying more payload than traditional airships but are operating at a much higher altitude. To support this extreme change in buoyancy, a concept of pressurized ballonets and hull is used in this model. This is similar to the design of prototype HLA's flying today including the Lockheed P-791. Figure 28 shows a sketch of this concept. This represents an area of ongoing research in the airship community but may be the only feasible way to lift heavy payloads to high altitudes. Several aerospace primes are studying HLAs for use as high altitude, long endurance, intelligence platforms.

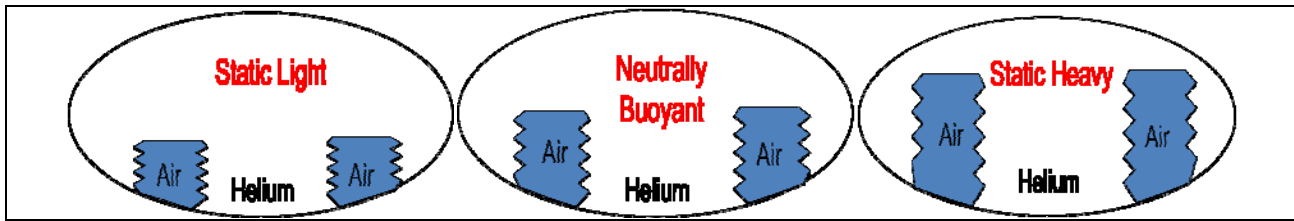

Figure 28: By expanding ballonets inside of the hull, the net buoyancy of the vehicle changes to manage lift. This requires the pressurization of the hull and the compression of air in the ballonets.

7.2 Cost Estimates

7.2.1 HLA Specific Modifications

Cost models associated with military aircraft must be modified to account for the increased size and payload capacity and the decreased cruise speeds of HLAs. The same RAND DAPCA CERs are used as a baseline for HLA costing but several changes are made. Refer to section 3 for the baseline costing model. The propulsion system development cost CER presented in section 3.1 is also modified for use in analyzing airships. Changes are as follows:

RDT&E/Acquisition Costs:

- 1) The difficulty factor is substituted with a design factor equal to 0.935. This design factor captures the reality that with an increase in altitude, the complexity of a HLA does not increase like an aircraft but only the amount of Helium it must carry and thus its size.
- 2) Only one prototype HLA shall be built and it will be given to the operational fleet once testing is complete. This is most likely a necessity given the effort that would be needed to build such a large vehicle.
- 3) The flight speed term used in the engineering and production labor terms is removed. This reflects the inherent difference between military aircraft, which grow in cost as flight speed is increased and airships, which are designed to fly slow.
- 4) An avionics cost of 1% of non-recurring cost is assumed.
- 5) Fly away cost includes all RDT&E and production split between the fleet.

Operations Costs:

- 1) Operations will require 1% helium volume replenishment after every mission. This is due to leaks or inefficiencies in internal gas handling. For 20km (65 kft) altitude airships, yearly Helium replenishment equates to

about 70% of 2008 U.S. production³⁸. Helium is assumed to cost \$2,000 per kilogram³⁹ to account for the additional cost of producing such large quantities.

- 2) 2 operators, 2 managers, 1 operation engineer, and 2 maintenance personnel are assumed to be present for every flight hour.

The small global airship fleet made finding costs of comparable systems difficult. Smaller blimps such as the Zeppelin NT carry only 1-2 tonnes of payload to 10,000 ft (3 km). Translating this airship type to geoengineering, a fleet of over 200 airships is required costing \$1.8B. Larger airships have not been produced since before World War II. The USS Akron's cost adjusted for inflation is approximately \$70M but its large payload allows a fleet of only 40 ships to fly to 26,000 ft (8 km) for a cost of just under \$3B. These two comparables, though for lower altitude vehicles, line up well with the cost estimates generated using the CERs (Figure 29).

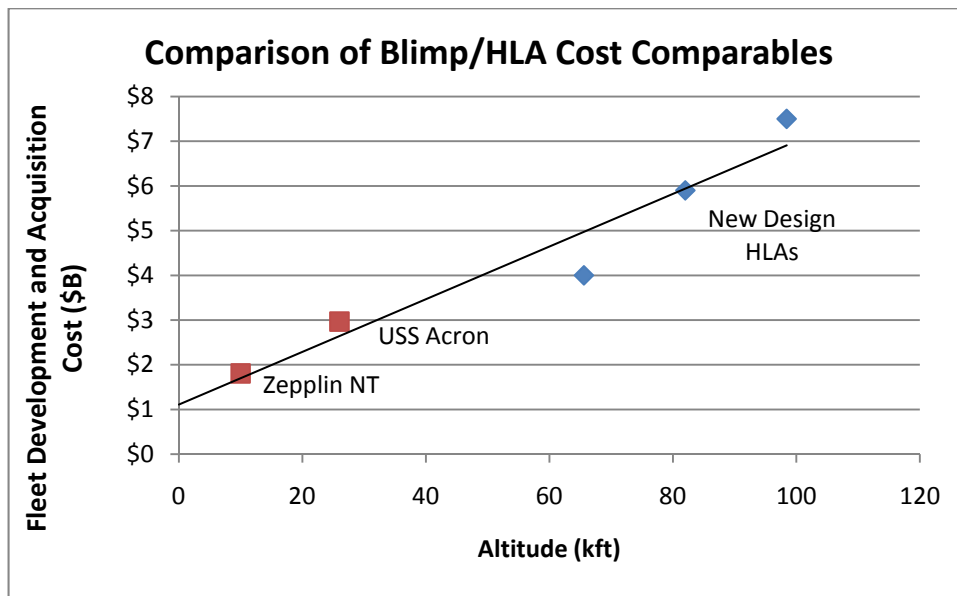

Figure 29: Comparison of fleet development and Acquisition costs for new design HLAs and comparable blimps

³⁸ “Mineral Commodity Summaries: Helium.” 2009. Online Posting. U.S. Geological Survey Minerals Resources Program. <<http://minerals.usgs.gov/minerals/pubs/commodity/helium/mcs-2009-heliu.pdf>> Accessed 9/10/2010.

³⁹ This value represents the cost of helium in a post Strategic Helium Reserve market where demand for helium for geoengineering operations has increased costs.

7.2.2 Uncertainty Analysis

As with aircraft, uncertainty analysis is performed to determine cost estimates sensitivity to changes in key design variables. Table 12 shows the input variables and their variation, which are slightly different from the aircraft analysis due to the nature of the models.

Table 12: Uncertainty Analysis varied key design variables to determine maximum and minimum cost

Variable	Variance
HLA Mass	+/- 10%
Engine T ₁₄	+/- 100 K
Max Engine Thrust	+/- 10%
Mission Time	+/- 40 min
Cost of Fuel	+/- 10%
Fuel Mass per Mission	+/- 10%

This analysis produced maximum and minimum costs for the top ranking architecture at each altitude. It is apparent that the most uncertain aspect of the cost estimates, similar to airplane cost estimates, is the engine RDT&E cost. To take this into account, an additional propulsion uncertainty is added onto the total non-recurring cost calculation as shown in Table 13. This uncertainty grows noticeably with altitude, but to a lesser degree than in airplane cost estimates which use a similar engine cost model but has larger propulsion cost uncertainty due to the limitations of integrating propulsion onto an airplane. This is due to the extra flexibility the airship allows. It is relatively simple to add an additional engine or gear box and larger propeller to the airship without impacting its payload significantly.

Table 13: Additional uncertainty due to specialized engine development needed to perform at high altitudes.

<65,000 [ft]	65,000 [ft]	80,000 [ft]	100,000 [ft]
No change	+/- 10% of Engine RDT&E	+/- 20% of Engine RDT&E	+/- 30% of Engine RDT&E

7.3 Conclusions

7.3.1 HLA and Campaign Optimization

While the model used in this study provided an effective design and evaluation tool, it is not a suitable optimization tool to find robust optima as is done in the new aircraft analysis presented in Section 5. Cases are chosen for evaluation based on previous studies and an estimated concept of operations, but the computational power was not available to actively search for these parameters in the design space. As a result, there is no

guarantee that an optimal solution was found but there is confidence in its general conclusions and demonstrated trends. The general trends are threefold

- 1) The designs tended to heavier payloads that take advantage of the buoyancy of the HLA.
- 2) Lower altitudes require smaller vehicles that can carry more payload, driven by the ratio of Helium density to atmospheric density at cruise altitude. This results in significantly simpler operations and manufacturing. The large size of airships for higher altitude is still an operational hurdle.
- 3) Cruise speed is constrained below 100 knots due to the large frontal area associated with HLA's. The slower cruise speed resulted in longer missions and a slower operations tempo.

There is also a clear advantage to modern HLA's at high altitudes where the volume of helium needed for buoyant flight in a traditional airship (LTA) becomes very large. The cost of systems at different altitudes also depends heavily on what altitude they are optimized for. Thus, the optimal solution at a given altitude will not perform well at other altitudes. The plots in the appendix 10.3 show the comparison between the optimal solutions and the LTA solutions.

7.3.2 Operational Constraints Considered

As with any vehicle, operations will place constraints on the design. For the subsequent analysis, the HLA's are constrained by existing hangars located in the US with the notional idea that similar facilities could be built around the world if needed. These facilities are shown in Table 14.

Table 14: Existing hangars on in the US constrain airships to 200x65x35 [m] or 650x210x110 [ft]

Location	Length [ft]	Width [ft]	Height [ft]
Akron, OH	1175	325	200
Moffett Field, CA	1170	231	124
Weeksville, NC	1000	220	160
Lakehurst, NJ	1000	220	160

7.3.3 Development and Acquisition Costs

Estimated costs of developing and acquiring the HLA fleet are shown in Figure 30. Each architecture has a different number of HLA's in the fleet but overall costs are comparable.

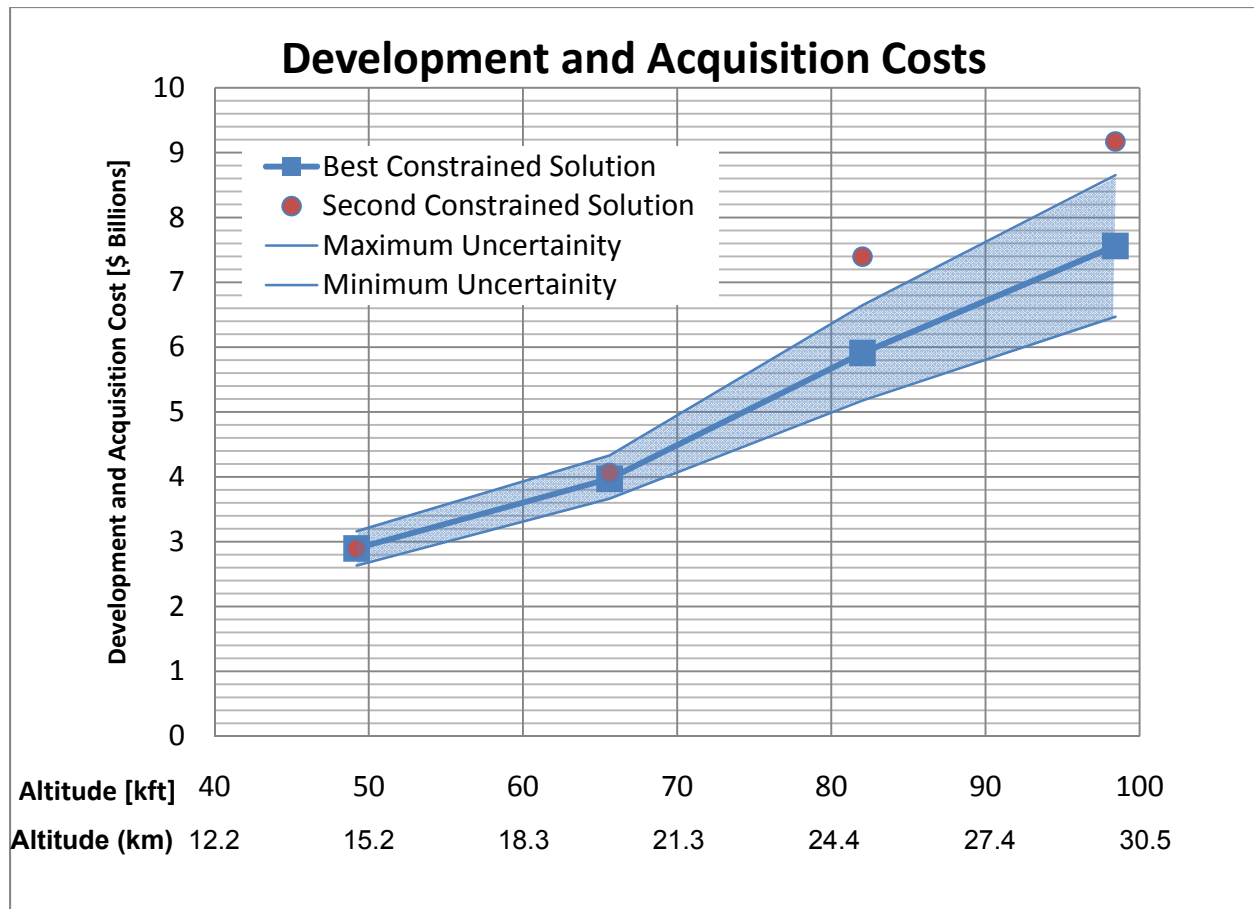

Figure 30: The total cost of the fleet in millions of dollars. Development and acquisition costs increase with altitude ranging from \$2.8 Billion to \$7.5 Billion although fleet sizes vary.

7.3.4 Yearly Operations Cost

Operations costs for each year include the entire fleet for a year fuel, personnel, helium replacement, and maintenance. As with the other cost models in this study, HLA costs do not include facilities or infrastructure. This is partly compensated by constraining the vehicles to fit within existing hangars. It should be noted that here are some non-trivial operational issues such as severe weather that may impact operations costs.

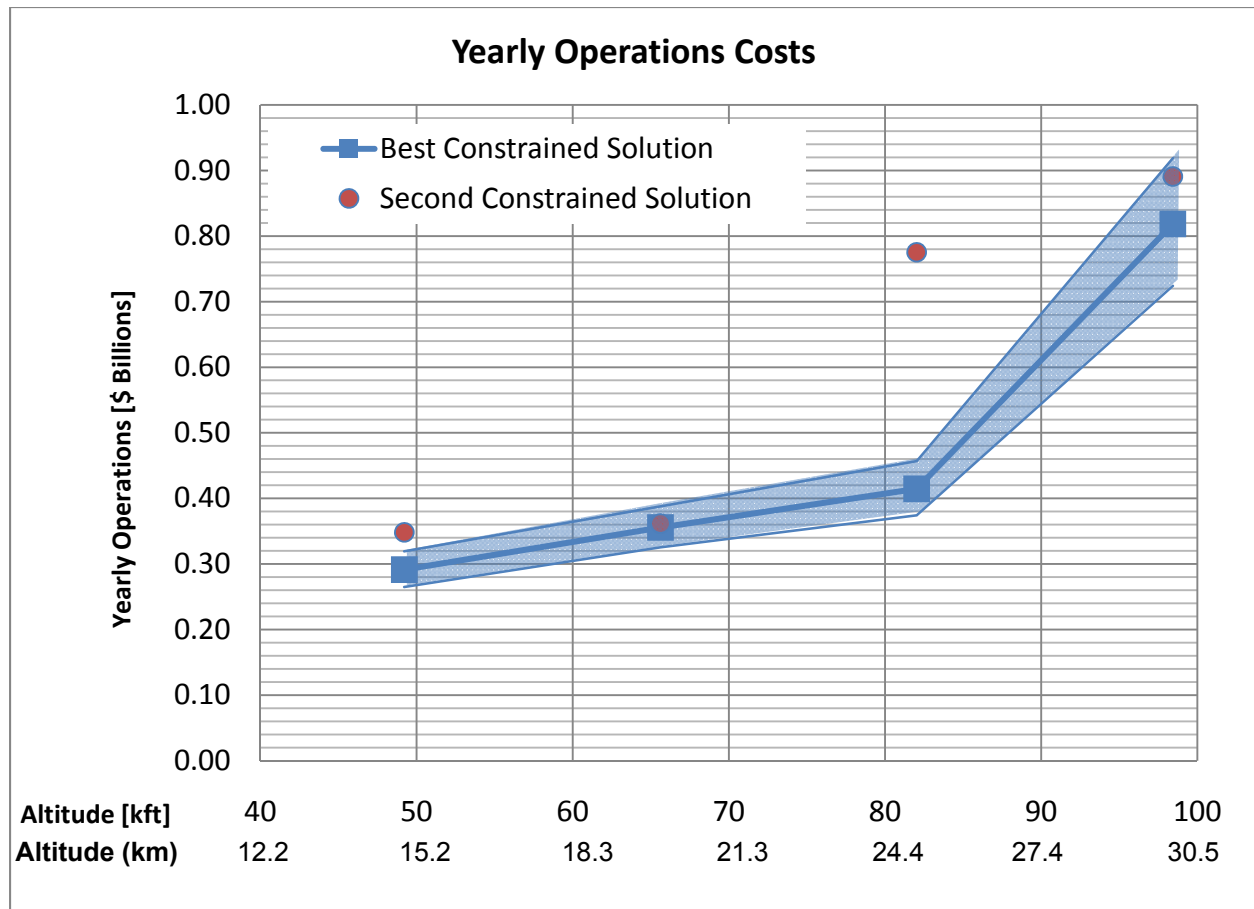

Figure 31: Yearly operations costs for airship geoengineering operations.

Figure 31 shows the fleet operating cost per year. The constrained solution shows a drastic increase in cost past 24.3 km (80kft) due to the large size and weight of the higher altitude HLA's. Air is simply very thin above 24.4 km, about 3.5% of the density at sea level, requiring large HLAs with small payload fractions. This drives up the fleet size and the number of sorties per year increasing fuel costs, personnel costs, and maintenance costs.

7.3.5 Total Yearly Costs

Yearly total costs were computed in the same manner as described for aircraft. Total yearly costs include cost of operations, interest payments for 20-year financing, and depreciation over 20 years.

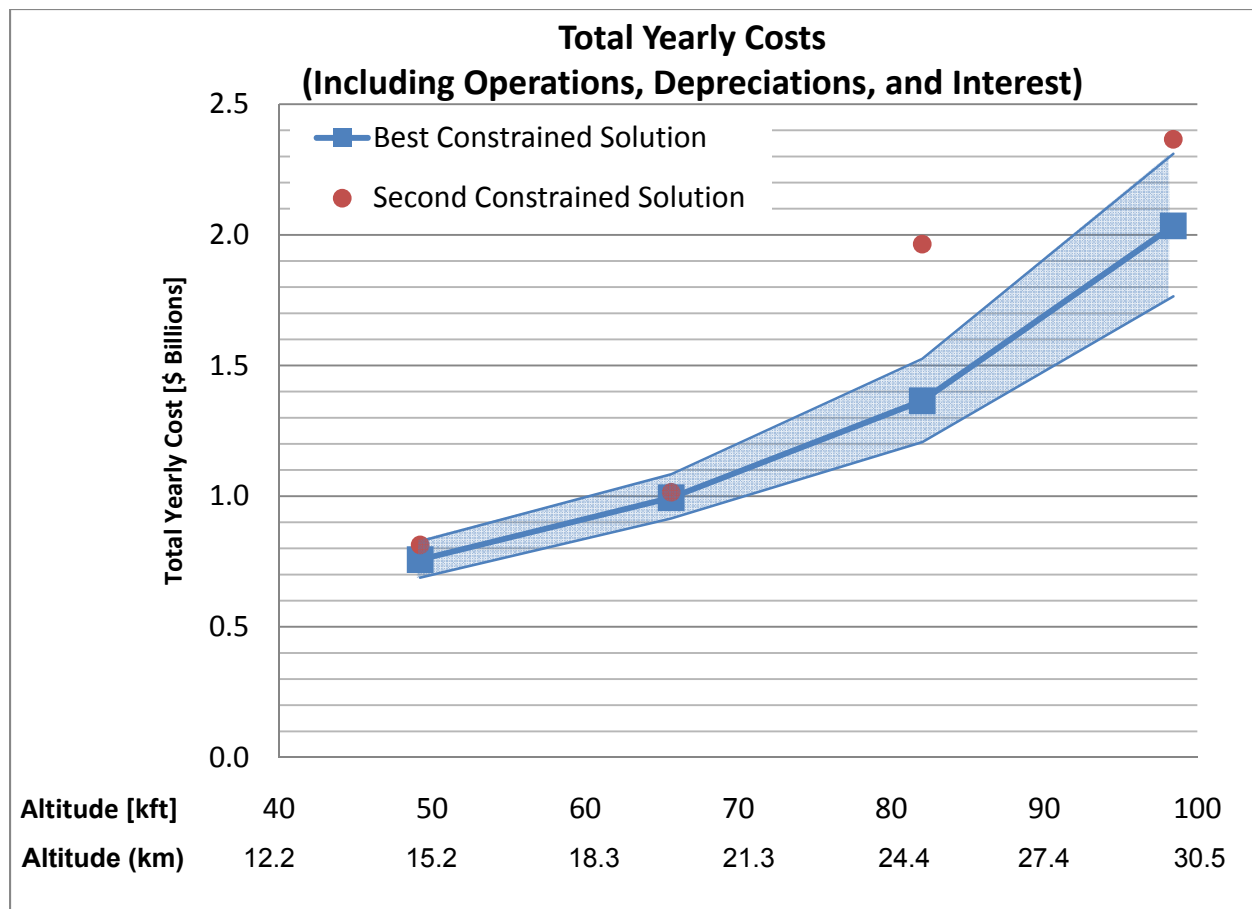

Figure 32: Yearly cost of operation including fleet operation and financial considerations.

Lower fuel costs and the smaller fleet size are likely to allow airships to beat airplane operating costs. Above 24.4 km (80kft) the air becomes too thin for airships to be a logical choice. The quantities of helium required increases while payload capacity shrinks, driving airship costs up.

Airships provide a low cost method to transport large quantities of payload, but significant development is required mature the HLA concept and move it to the high altitude required for geoengineering. While the CERs developed for airships provide a good estimate of cost, current HLA development efforts are higher than these estimates and reflect the immaturity of this technology.

The end goal of these recent HLA development efforts is a 65,000 ft capable airship, so that altitude is used for comparison purposes. It is important to note that current HLA prototypes have not exceeded 20,000 ft (6 km) and that even proposed prototypes are being design for 20,000 ft demonstration. The Northrop Grumman HLA development effort with up to \$500M to produce up to three HLAs capable of carrying an estimated 1,500 kg provides a per ship cost of \$166M. This provides one upper bound for geoengineering airships fleet costs of \$45B. The Lockheed P-791 HLA prototype, with an estimated 1,000 kg payload, was developed for over \$100M providing a second HLA fleet

cost upper estimate of \$40B. These maximum theoretical airship costs bring the maximum total yearly cost for airships up to the \$8B-10B range.

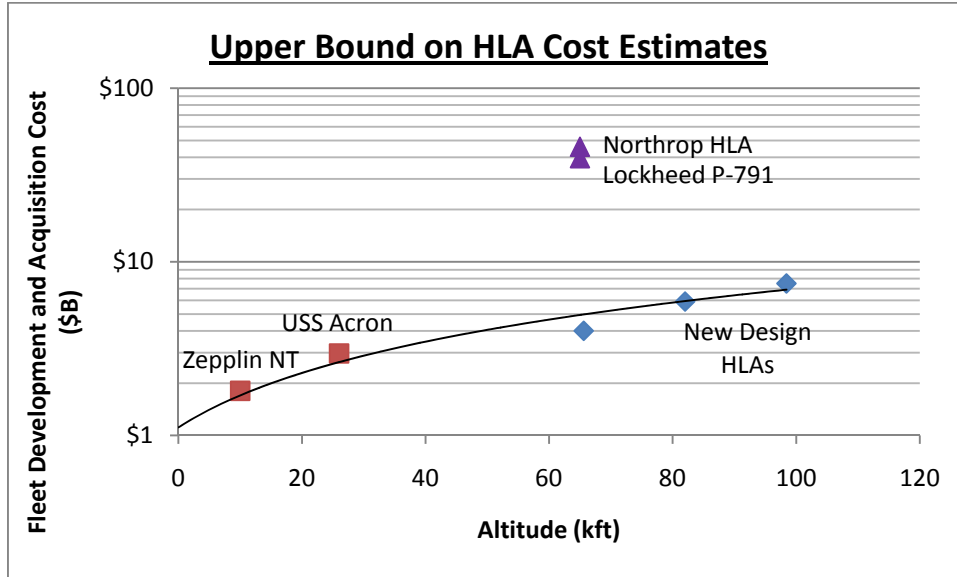

Figure 33: Comparison of fleet development and Acquisition costs for new design HLAs including recent HLA development efforts which provide an upper bound to cost estimates.

Airships offer less propulsion development risk than airplanes due to their large size and large payload fraction. For example, imagine during the development of the geoengineering aircraft presented in section 6, that drag is higher than initially estimated. Additional thrust is needed so the 10,000 kg payload would need to be reduced to allow addition of an additional 1,500 kg engine. This represents a 15% reduction in payload, and will increase fuel consumption requiring an additional reduction in payload. A similar drag increase on the airship, requiring an additional 1,500 kg engine, will only reduce the airship’s 40,000 kg payload by 3.7% minimally impacting the fleet size and sortie rate.

The majority of the airship’s technical risk comes from extending the technology to high altitude. As the air gets thinner, the airship must increase in size to generate adequate buoyancy and lift in less dense air. This pushes the structural design to the limit. The presence of high altitude winds increases the propulsion requirements on the HLA and transitioning through wind currents such as the jet stream may expose the vehicle to large wind shear, further increasing structural requirements.

8 Non-Aircraft Systems

8.1 Rocket Powered Glider

An analysis of a rocket powered system was carried out for comparison to airplanes. The concept vehicle utilizes off-the-shelf rocket engines or motors to boost a vehicle and payload to altitude. At apogee wings are deployed to increase the vehicle's lift-to-drag coefficient to allow it to glide at altitude and disperse payload. Once dispersal is completed, the wings retract to allow it to descend quickly.

8.1.1 Cost Estimate

Though rocket glider cost estimates were developed, a preliminary analysis proved this architecture is far too costly when compared to other systems. An initial estimate is made using the cost per kilogram of existing rocket systems. Both sounding rockets and orbital rockets were examined. Orbital rocket costs per kilogram are scaled down by 1/7 to account for the reduced complexity and energy required to achieve high altitude instead of orbit. Seven sounding rockets and seven orbital rockets costs were compared. Similarly, suborbital rockets costs were scaled to equalize costs based on a constant altitude and payload capability. The results are shown in Figure 34.

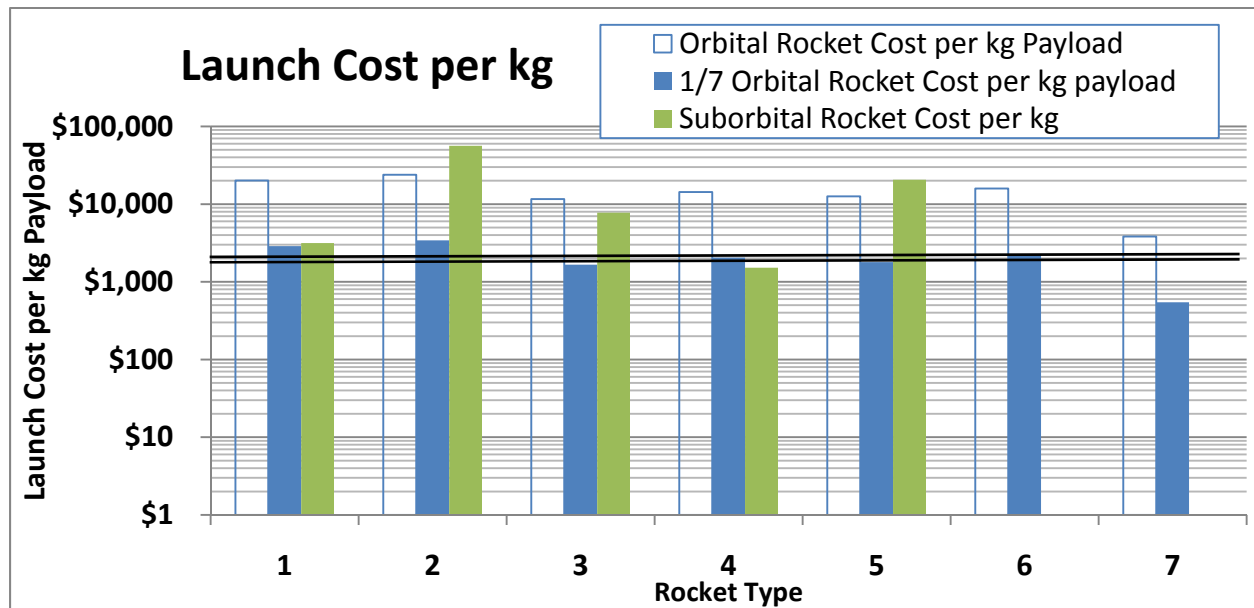

Figure 34: Comparison of orbital and suborbital rocket costs per kilogram launched. Orbital rocket costs are included scaled by 1/7 to account for the reduced energy required for a suborbital launch. The black line indicates the average of the cost of \$2,086/kg for a 1/7 scaled orbital rocket.

The average cost computed from the 1/7 orbital rocket cost is \$2,086 / kg. This is in line with several published values that price a suborbital rocket launch as about \$2,000 / kg⁴⁰. At this rate, launching 1M tonnes a year to altitude would cost \$2,000B per year. Based on this initial estimate, rockets are not complete from a cost standpoint.

Rocket motors and engines produce extremely large amounts of energy through controlled combustion of highly volatile chemicals. For this reason, a typical rocket has a failure rate of several percent. Because these chemical propellants and oxidizers are carried with the rocket, payload fractions are small and a large number of launches would be required to achieve geoengineering up-masses. With a 5,000 kg payload, 200,000 launches a year would be required. If rockets can be refueled and refurbished in 1 month, each rocket can fly 12 sorties a year. If no failures occur, a fleet of about 16,000 vehicles is required. If a failure rate of 5% is assumed (equivalent to that of a Delta-class rocket), a staggering 10,000 rockets will be lost per year. These losses dominate acquisition requiring a total fleet size of over 216,000 rockets with almost all lost due to failures. Clearly, rockets are not a viable system for geoengineering.

8.2 Guns

Conventional guns as well as more advanced gun designs were examined. Matlab models originally developed to model rocket launch and ballistic coast were easily adapted to guns and used to verify projectile apogee height.

Table 15: Gun System Analysis Inputs

Item	Value ^{41,42,43}
Shell Mass (kg)	862
Payload Per Shell (kg)	70
Gun powder Mass per shot (kg)	297
Powder Cost per kg	\$22
Muzzle Velocity (m/s)	760
Cost per New Barrel (\$)	\$7,500,000

⁴⁰ Mains, Richard. "Commercial SubOrbital Science: A Game-Changer for Micro-g R&D." Commercial Space Gateway. May 4th, 2009. <http://www.commercialspacegateway.com/item/19040-commercial-suborbital-science-a-game-changer-for> (May 26th, 2010)

⁴¹ http://www.ussnewjersey.com/hist_sts.htm

⁴² United States. National Academy of Sciences, National Academy of Engineering, Institute of Medicine. Policy Implications of Greenhouse Warming- Mitigation, Adaptation, and the Science Base. Washington: National Academy Press, 1992

⁴³ http://www.navweaps.com/Weapons/WNUS_16-50_mk7.htm

Cost of Shell	\$3,000
Full Time Personnel Per Barrel	2
Fire Rate	2 / min
Shots Per Barrel Lining	1500
Cost Of Barrel Relining	\$335,000
Barrel availability due to relining, maintenance	50%

The basis for this analysis is the 16" Iowa class Mark 7 naval gun. While there are new gun technologies under development that utilize electromagnetics, the 16" naval guns represent a mature, deployable technology with almost a century or heritage. Inputs to gun calculations are show in Table 15 with all costs in 2010 dollars.

These inputs differ from previous work on guns for geoengineering by the National Academy⁴². The National Academy study assumes a payload fraction of 50%. At that high a payload fraction, the projectile shell may not be strong enough to withstand ~35,000 g experienced during firing. Additionally, particulate density is lower than steel density so high payload fractions may lighten the projectile limiting its range and altitude. The National Academy assumed a cost of \$2 trillion to set up a 400 barrel gun system, this seems very high and differs dramatically from the \$7.5M per-barrel acquisition cost used in this analysis. The National Academy also used a higher value for the cost of barrel replacement/relining, this drove their solution to much lower firing rates and many more guns. Their analysis used a fire rate of every 12 minutes while this analysis uses a shot every 2 minutes. The Academy assumed operations 250 days a year equivalent to an availability of 68%. Finally, the Academy assumed 10 personnel for each gun while this study assumed more automation and employed only 2 people per gun.

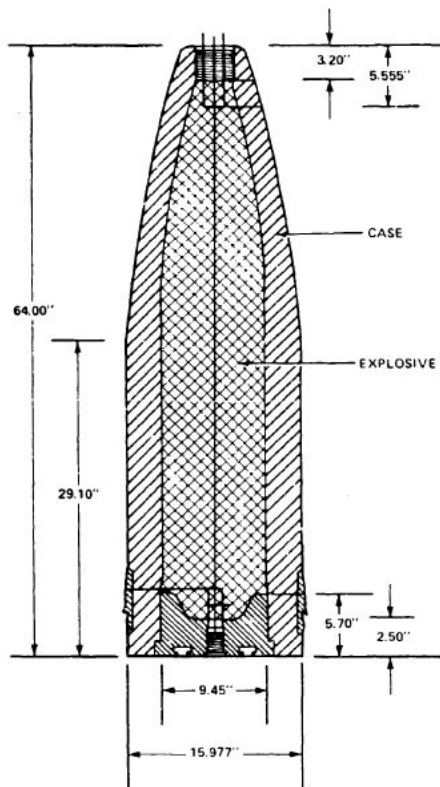

The guns have no trouble launching a projectile to altitudes as high as 30 km (100 kft) when firing at an angle of 85 to 90 degrees with a 760 m/s muzzle velocity.

Analysis is conducted assuming 1M, 3M, and 5M

Figure 35: A 16"/50 Mark 13 projectile weighing in at 862 kg. By design it carries a 70 kg payload. Note the greater than 8 cm thick casing to withstand g-loads of firing and increase weight. (http://www.navweaps.com/Weapons/WNUS_16-50_mk7_pics.htm)

tonnes up-mass per year. Costs

predicted for a gun system are heavily dependent on projectile payload fraction. With the 70 kg explosive payload replaced with geoengineering material the shells have a payload fraction of only 8%. This means to achieve 1M tonnes up-mass per year, 14,000,000 shots must be fired each year. A payload fraction of 50% was also analyzed to serve as a lower bound for cost.

The barrel linings need to be replaced after approximately every 1,500 shots⁴⁴ (about 48 hours of firing). If it is assumed that the barrels are removed for relining elsewhere and a fresh barrel is installed, we can assume this process takes an estimated 3 hours. Thus each gun is then available 93% of the time. Availability was reduced to 50% to take into account maintenance on loading mechanisms and other components. Crew costs are rather conservative, as the firing process can be automated. Labor is assumed to be 1 operator and 1 maintenance technician 24-hours a day for each barrel and 1 manager for 8 hours per day for each set of 10 barrels. The cost of setting up the guns and associated breach loading systems, projectile conveyors, and gun mounts is \$7.5M per barrel.

8.2.1 Cost Estimate

The gun based system was the cheapest to develop and acquire. This is due to the maturity of the technology involved, having been used on battleships for approximately 70 years. A gun system would require a large number of barrels with automated loading systems and barrel lining replacement systems. A rate of \$7.5M per barrel was assumed for the construction of the gun loading and control systems. The largest expense associated with operating the guns is cost of projectiles. This is due to the 10% payload fraction of a conventional 16" projectile. Even though each projectile is relatively cheap at \$3000 each, with 14M projectiles needed each year, costs are exorbitant. The recurring cost per kilogram to 21.3 km (100kft) altitude is \$140. It should be noted that the cost per shot of \$9,500 within the same order of magnitude as the National Academy value of about \$15,000 per shot (adjusted for inflation) shown in Table 16.

Table 16: Costs estimates for geoengineering gun system. Numbers based on Mark 7 U.S. Naval guns with a 10% payload fraction. Previous estimates by the National Academy of Sciences (adjusted for inflation) are included for comparison (50% payload fraction).

⁴⁴ Originally the linings lasted only 290-350 shots, but with the use of modern linings on powder bags, gaseous erosion was significantly reduced. (http://www.navweaps.com/Weapons/WNUS_16-50_mk7.htm)

	Shots per year	Number of Guns	Number of Barrels Replaced Per Year	Shell Cost Per Year	Powder Cost Per Year	Barrel Reline Cost Per Year	Cost Per Shot (\$)	Depreciation Per Year	Total Yearly Cost
1M Tonnes/ yr	14,000,000	110	9,520	\$43B	\$93B	\$3.2B	\$9,770	\$0.06B	\$140B
3M Tonnes/yr	43,000,000	330	28,570	\$128B	\$280B	\$9.6B	\$9,770	\$0.18B	\$419B
5M Tonnes/yr	71,000,000	545	47,600	\$215B	\$466B	\$16.0B	\$9,770	\$0.30B	\$700B
Natl. Ac. 5M Tonnes/yr	10,000,000	400	8000	\$113B	\$13.6B	\$11.3B	\$14,090	\$45B	\$185B ⁴⁵

These numbers are based on a gun system developed in 1939. To attempt to model a more advanced gun system several modifications are made to the original Mark 7 gun model (Table 17). Payload fraction is increased to 50% (431 kg per shot) to take into account stronger, denser materials used in the projectile. This is in line with National Academy payload assumptions. The projectile cost is reduced to \$1,500 to account for more automated manufacturing processes. Finally, barrel wear is increased to require relining every 3,000 shots to account for the use of advanced materials.

Table 17: Costs estimates for modernized geoengineering gun system. Numbers based on Mark 7 U.S. Naval guns but with barrel linings lasting twice as long, 50% payload fraction, and projectile cost halved. Previous estimates by National Academy are included for comparison (50% payload fraction).

	Shots per year	Number of Guns	Number of Barrels Replaced Per Year	Shell Cost Per Year	Powder Cost Per Year	Barrel Reline Cost Per Year	Cost Per Shot	Depreciation Per Year	Total Yearly Cost
1M Tonnes/ yr	2,300,000	18	775	\$3.5B	\$15.1B	\$0.26B	\$8,160	\$0.009B	\$19B
3M Tonnes/yr	7,000,000	53	2,320	\$10.5B	\$45.5B	\$0.78B	\$8,160	\$0.03B	\$57B
5M Tonnes/yr	12,000,000	90	3,870	\$17.5B	\$75.8B	\$1.3B	\$8,160	\$0.05B	\$95B
Natl. Ac. 5M Tonnes/yr	10,000,000	400	8000	\$113B	\$13.6B	\$11.3B	\$14,090	\$45B	\$185B ⁴⁵

⁴⁵ To maintain an equal comparison, only 45% of the \$2T acquisition cost for the National Academy system is depreciated to obtain total yearly cost. An inflation adjustment of 1.51 was used to escalate National Academy 1992 dollars to 2010 dollars.

Even with these improvements, the cost per shot is reduced by only \$1,500. This represents a cost of \$19 per kilogram to 21.3 km (100kft). The improved system with a 50% projectile payload fraction has yearly costs of about 50% less than the values calculated by the National Academy using a 50% payload fraction. Differences in shell cost account for about half of this discrepancy. The remainder can be attributed to the higher acquisition cost of the gun system in the National Academy analysis adding approximately \$45B in depreciation per year.

8.2.2 Conclusions

While costs calculated here and those from the National Academy are comparable, the gun system is too expensive to be competitive with airplanes and airships. For this system to be competitive, cost per kilogram must be reduced significantly by reducing projectile cost or increasing projectile payload to reduce number of shots required. That said, the benefit of 30.4 km (100kft) capability may justify the higher cost of the gun system.

8.3 Floating Platform with Slurry Pipe / Gas Pipe

Analysis was conducted on systems utilizing a lighter-than-air platform to support a pipe^{46,47}. For simplicity a single monolithic floatation platform to support the pipe and a single pump at the base are modeled. This allows prediction of the platform and pipe system RDT&E costs using the airship cost model. Systems carrying a liquid slurry solution (density of 1000 kg/m³, equal to water), and a gas (density of 1.22 kg/m³, equal to atmospheric density at sea level) are examined. It should be noted that the gas system is not a chimney, as buoyancy is not being used to propel the gas. Altitude is limited to 21.3 km (70kft) to limit the size of the floatation structures.

8.3.1 Feasibility and Design

It is important to note that these systems are purely theoretical and push the limits of today's materials and technologies. Analysis was conducted to determine approximate costs for comparison purposes but uncertainty is very large and true development costs are extremely difficult to predict. Deploying these systems may require significant advancements in fluid mechanics, aerodynamics, and material science.

⁴⁶ Intellectual Ventures Lab. [The Stratospheric Shield](#). Bellevue, WA: Intellectual Ventures, 2009

⁴⁷ Jason Blackstock, D.S. Battisti, Ken Caldeira, D.M. Eardley, J.I. Katz, David W. Keith, A.A.N. Patrianos, D.P. Scharg, Robert H. Socolow, and S.E. Koonin. [Climate engineering responses to climate emergencies](#). Technical report, Novim, July 2009

These systems trade two primary design drivers. First, the diameter of the fluid pipe dictates the weight of the column of fluid in the pipe and the weight of the pipe itself, driving the quantity of helium required to provide buoyancy and therefore the size of the floating platform. Second, the diameter of the pipe dictates how fast the flow must travel to meet the yearly up-mass rate, dictating the pressure needed to drive the fluid to altitude while overcoming friction in the pipe. These drivers compete: for a small platform a thin pipe is desirable but thin pipes require fast flows, have higher frictional losses, and require excessive pressures. A large pipe and platform allows slow moving flow, but at some size the feasibility of building a floatation platform becomes questionable.

To determine the feasibility of building a pipe system, a pipe diameter trade was performed to balance the two primary design drivers. A floatation platform of less than 300 m in diameter (as represented by a helium sphere) is desired. This platform size is significantly larger in volume than the largest airship built to date, the USS Akron, but comparable in linear dimension. For example, a typical NASA scientific balloon expands to 140 m at high altitude. Given advances in modern CAD/CAM and material technology this size seems like a feasible size for a platform. A maximum feasible pipe pressure of about 3,000 Atm (303 MPa; 44,000 psi) is also determined based on the hoop stress in the pipes. While a pipe with thicker walls could withstand greater pressure, the weight of the pipe causes the platform to grow far beyond the 300 m limit. In the following plots, the region of the design space within this realm of technology is approximately shown by the green shading.

The pipe has to resist several stresses making its design a challenge. There is a hoop stress on the pipe from the pressure of the fluid inside it. There is a tensile stress on the pipe due to its weight and the weight of the fluid. Additionally, the pipe and the floating platform must be able to resist atmospheric winds. Sections of the pipe and potentially the floating platform itself may be exposed to winds of up to 120 kts. This will put large shear and additional tensile stress on the pipe increasing its required strength. Distributed floatation along the pipe's length reduces the tensile stress on the pipe but will exacerbate wind shear. Adding pumps distributed along its length would reduce pressure and loads as well. Additional trade studies are required to determine the benefits and disadvantages to distributed floatation and pumping. Details about the pipe stress and strength are discussed in more detail in the following sections.

8.3.2 Liquid Slurry Pipe

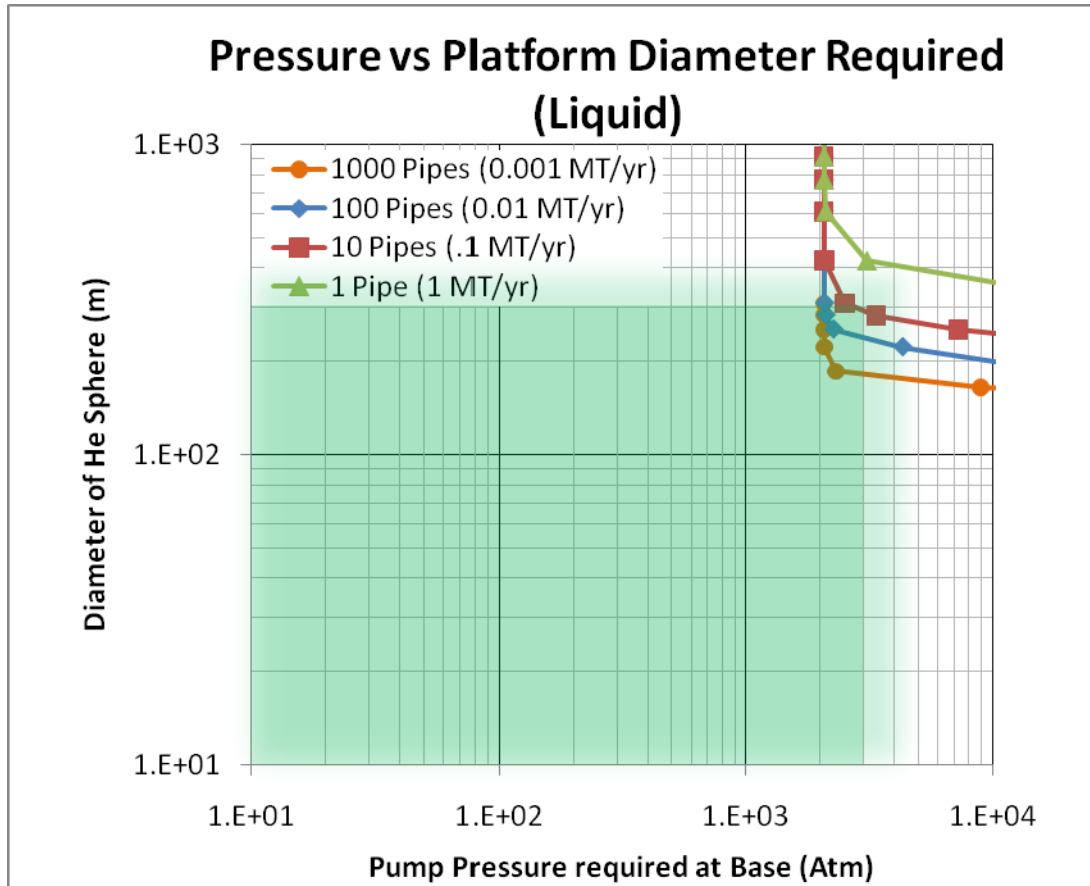

Figure 36: Pipe diameter trade between platform diameter (diameter of helium sphere) vs. pump pressure required to pump liquid to 21.3 km (70kft). The design space of reasonable (300 m platforms, 3,000 Atm pipe pressure) is shown in green. System cost can be reduced by minimizing pressure and platform size. Pressures can be maintained close to 2,000 atmospheres without requiring a platform beyond reasonable limits.

Figure 36 shows the trade between the pressures required to pump a fluid to 21.3 km (70kft), overcoming friction and gravity, versus the size of the floating platform required to support the pipe and column of fluid. The pipe is assumed to be a 70% carbon fiber matrix composite with a 10 mm wall thickness and a density of 1600 kg/m³, though pipe sections will need to be connected via a flexible coupling to allow movement.

For the liquid slurry system to be viable, between 10 and 100 pipe/platforms are required. At 34 pipe/platforms, the pressure required to pump the fluid is 2,200 Atm with a platform diameter of 301 m. Pipe diameter is 0.04 m. This represents a good balance between pressure, platform size, and number of pipe/platforms while being a low cost solution balancing RDT&E costs limiting pressures to reduce pump electricity costs.

A lengthwise maximum strength for a 70% carbon fiber matrix composite is 1.5 GPa. Assuming roughly half the fibers run lengthwise to resist the tensile strength and half run circumferentially to resist the hoop stress, the actual strength of the pipe is 750

MPa. These values include no margin for safety or for carbon fiber allowables⁴⁸. The maximum pressure near the base of the pipe creates a hoop stress in the pipe of 894 MPa. The weight of the pipe and the fluid is 1,150 kN causing 732 MPa tensile stress in the pipe. There is an additional stress on the pipe due to wind that has not been calculated here. It is important to note that the hoop stress is reduced with height so the pipe could be tailored to have more hoop strength near the base and less at altitude, lightening the whole structure. In summary, the slurry pipe concept does not violate physics or material science, but will require innovative engineering to achieve a feasible design with appropriate allowable and safety margin.

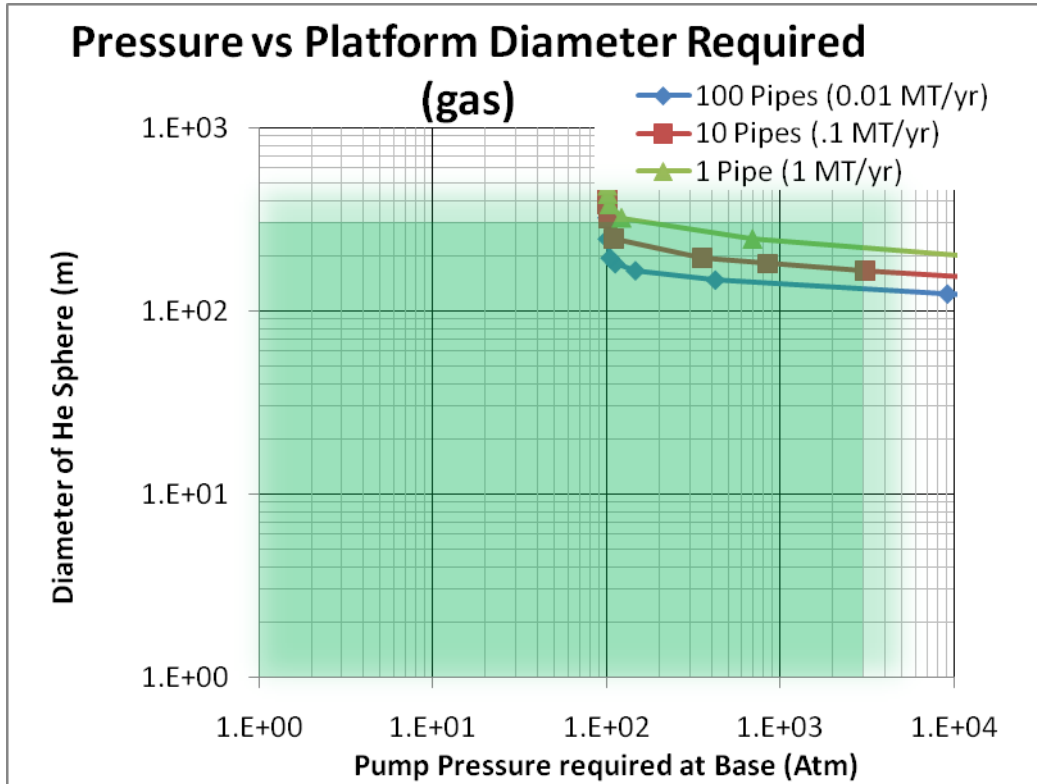

Figure 37: Pipe diameter trade between platform diameter (helium sphere diameter) required to support pipe carrying air to 21.3 km (70,000 ft) vs. pump pressure required at base to move the air. The design space of reasonable (300m platforms, 3000 Atm pipe pressure) is shown in green. Pressures required to move the gases can be reduced as low as 100 Atm without requiring an excessively large flotation platform.

⁴⁸ Allowables are material specifications with a certain probability of meeting or exceeding a specific value. For example, the 1.5 GPa strength given here is a 50% allowable. This means 50% of the structure will have a higher strength and 50% will have a lower strength. To ensure a safe design, a 95% or 99% allowable should be used which is typically 1/2 to 1/3 the value of the ideal 50% value. For the pipe case this means only the strongest 50% of the pipe sections produced will be used (increasing price) or the strength property used to design the pipe should be reduced to the 95% or 99% allowable.

8.3.3 Gas Pipe

Figure 37 shows the pipe diameter trade between the pressures required to pump a gas to 21.3 km (70kft) versus the size of the floating platform required to support the column of gas. The pipe is assumed to be a 5 mm wall thickness 70% carbon fiber reinforced composite. The primary differences between the gas pipe and the liquid slurry pipe are the non-uniform density and the lower viscosity of the gas. The gas pipe carries a compressible gas so the density of the column of gas is not uniform. The gas near the bottom of the pipe is pressurized as it pushes the column of gas upwards against the force of gravity and friction.

The gas system requires between 10 and 100 pipe/platforms. Pressures are significantly reduced over the slurry system due to reduced density and viscosity of the gas, but the larger pipe diameters required to move the low density gas cause the pipe weight to be double that of a comparable liquid system even with half the wall thickness required to resist pressure. The gas system optimizes to about 90 systems with 0.21 m diameter pipes. This requires a platform of 330 m in diameter, only 10% larger than the limit of 300 m. Pressures at the base of the system are 156 Atm.

The 70% carbon fiber matrix composite pipe has a maximum strength of 1,500 MPa. This translates to 750 MPa in the lengthwise and circumferential direction (neglecting allowable and safety margin) when plies are aligned at 90° to each other to carry the orthogonal loads. The maximum pressure near the base of the pipe creates a hoop stress in the pipe of 666 MPa. The weight of the pipe and the fluid is 1,525 kN causing 450 MPa tensile stress in the pipe. These values indicate the system is feasible but has little margin for safety or for carbon fiber allowables. Again, note that the hoop stress is reduced with height so the pipe could be tailored to have more hoop strength near the base and less at altitude, lightening the whole structure. In summary, the gas pipe concept does not violate physics or material science, but will require innovative engineering to achieve a feasible design. Properties for the gas pipe and the slurry pipe system are tabulated below (Table 18).

Table 18: Properties of Slurry Pipe and Gas Pipe systems

	Liquid Slurry	Gas Pipe
Wall Thickness (m)	0.010	0.005
Pipe Diameter (m)	0.040	0.210
Area of Pipe (m ²)	0.0016	0.0034
Tensile Force due to weight (N)	1,151,000	1,525,000
Platform Size (dia He sphere, m)	300	330
Tensile Stress @ Max weight (Pa)	732,572,000	451,586,000
Max Pressure (Pa)	223,694,000	15,870,000
Max Pressure (Atm)	2,200	160
Hoop Stress @ Max pressure (Pa)	894,777,000	666,534,000

Ultimate Strength (CF 70%) (Pa)	1,500,000,000	1,500,000,000
---------------------------------	---------------	---------------

8.3.4 Cost Estimate

The development costs of a pipe strong enough to constrain the floating platform in the presence of high altitude winds as well as resist the extremely high pressure exerted on the pipe are difficult to predict. With carbon fiber prices on the order of \$22 per kilogram and the pipe containing up to 114,000 kg of carbon, the material costs for the pipe are \$2.5M. Development of more advanced materials, engineering and development of the pipes themselves, and testing costs are harder to predict for such a unique pipe application and easily exceed \$1B and may reach perhaps \$20B. A value of \$10B is used for cost estimates.

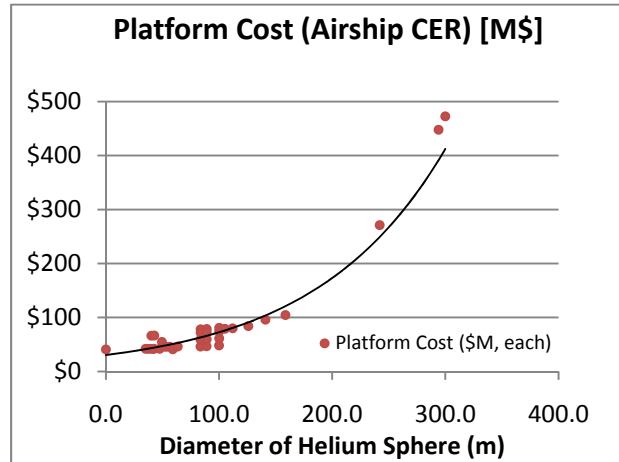

Figure 38: Cost of floatation platform based on airship CER presented in section 7.2.1. Points indicate an airship cost determined with the airship CER. The curve fit was used for cost of the floating platforms.

The costs associated with building a 10 or 100 dirigibles 300 m diameter are easier to estimate so that will be the focus of the pipe/platform cost calculations. Utilizing the airship CERs (Figure 38), a 300 m (0.014 km³) floatation platform costs approximately \$415M. This cost seems reasonable due to the complexity of piping, pumps, and high pressure equipment. Additionally the floatation platform may make use of propulsion to counter the effects of winds aloft. Considering the similarity between the floating platform and a deep water oil drilling rig, both support miles-long pipe systems while pumping high pressure drilling fluids and processing high pressure (up to 2,000 Atm) oil and gas, the drilling rig cost seems to be a good upper bound for platform cost. At 106x70m the Cajun Express deep water oil drilling rig pictured in Figure 39 rents out at about \$500,000 per day and has a cost of about \$600M. This is in good agreement with the values predicted by the CER.



Figure 39: The Cajun Express deep water drilling rig. At 106x70m and with up to 10.6 km (35kft) of pipe down to a pocket of high pressure oil and natural gas, these off shore rigs are analogous to a floating geoengineering platform (Transocean image, <http://www.deepwater.com/fw/main/Cajun-Express-52C17.html>).

The liquid slurry system requires 34 platforms and slurry pipes to reduce pressures and platform buoyancy re-

quirements enough for the system to be feasible. With a platform of 301 m in diameter, each pipe/platform has a \$418M acquisition cost. Adding \$10B for pipe development brings initial costs to \$24.2B.

A 90 platform gas pipe systems requires a floatation platform of 330 m in diameter costing \$540M each, combined with \$10B for pipe development, RDT&E and acquisition cost are \$58.6B.

Assuming some automation, a crew of 2 full time engineers and 2 full time maintenance technicians run each platform. Two additional technicians supplement each crew for 8 hours each day and there are 2 managers per 10 platforms overseeing operations (1 manager for the single platform case). Total personnel costs were estimated at \$3.5M per year per platform plus management costs. This equates to \$120M in yearly personnel costs for the 34 slurry pipes and \$330M in personnel costs for the 90 gas pipes. Required pump power is determined by adding the power required to overcome friction to the power required to overcome the weight of the fluid. First the pressure to overcome viscous frictional losses in the pipe is converted to a head height (in meters). Using the pump power formula below, a friction power is determined. This is added to the power required to overcome the weight of the fluid, derived from the same pump power formula but using the 21.3 km (70kft) height of the fluid column.

$$\text{Friction Head Height (m)} = P[\text{Pa}]/(\rho * G)$$

$$\text{Power}_{\text{pump}}(\text{kW}) = \left[\frac{\left(\dot{V} \left[\frac{\text{m}^3}{\text{hr}} \right] \right) \left(\rho \left(\frac{\text{kg}}{\text{m}^3} \right) \right) \left(G \left[\frac{\text{m}}{\text{s}^2} \right] \right) (H [\text{m}])}{3.6 * 10^6} \right] * e$$

Where:

- P = pressure at base of column
- P = density of the fluid
- G = acceleration due to gravity
- \dot{V} = Volumetric flow rate
- H = head height
- e = pump efficiency

Assuming a standard pump efficiency of 60%, each liquid slurry pipe requires 330 kW to run. Over a year, this equates to 2,890 GW-h for each slurry platform. Industrial electricity rates in the US range from \$0.05 to \$0.18 per kW-h, assuming the median rate of \$0.11 per kW-h, each slurry pipe's pumps costs \$0.318M to run for one year. With 34 pipes required to move 1M tonnes per year, total electricity costs are about \$10.8M.

Each gas pipe requires 110 kW to run. Over a year, this equates to 963 GW-h for each pipe/platform. Assuming a median electricity rate of \$0.11 per kW-h, each pipe's pumps costs \$0.106M to run, or \$9.5M for the set of 90.

Some aspect of the system will need to be repaired or refurbished during its life. The cost of spare parts and maintenance is assumed to be 10% of the acquisition cost divided over the 20 year system life. This brings total yearly cost for a slurry pipe system to approximately \$4.1B. Estimates for total yearly costs for the gas pipe system are about \$10.1B per year. A summary of the costs of the two systems is included below.

Table 19: Summary of costs for slurry pipe and gas pipe systems

	Electricity Cost (\$M/yr)	Personnel Costs \$M/yr	Spares Cost (\$M/yr)	Operations Cost \$/Kg	Platform Cost Each (\$M)	Total Platform + Pipe Cost (\$M)	Depreciation (\$M/yr)	Interest (\$M/yr)	Total Yearly Cost
Liquid:	\$10.9	\$120	\$121	\$0.25	\$418	\$24,200	\$1,090	\$2,800	\$4,140
Gas:	\$10.6	\$331	\$293	\$0.63	\$540	\$58,640	\$2,640	\$6,790	\$10,060

9 Conclusions

The primary conclusion to draw from this feasibility and cost study is that geoengineering is feasible from an engineering standpoint and costs are comparable to quantities spent regularly on large engineering projects or aerospace operations. Airplane geoengineering operations are comparable to the yearly operations of a small airline, and are dwarfed by the operations of a large airline like FedEx or Southwest. With yearly costs including interest payments and depreciation for a 1M tonne up-mass costing about \$1B to \$2B for a new airplane design, planes are competitive with systems utilizing other technologies. Airships provide about a \$0.5B savings over airplanes and are even more attractive from a cost and technological risk standpoint. Other systems do provide access to high altitude. Suspended pipe systems are competitive and offer the lowest recurring cost per kilogram, but more thorough analysis is required to determine their true feasibility and refine development cost estimates which are difficult to predict.

9.1 Comparison of All Systems

The table below (Table 20) summarizes the costing results for all the systems examined. New airplane designs, optimized for low cost and designed to fulfill the geoengineering mission had low recurring costs. This low operating cost comes at the expense of additional RDT&E and acquisition cost. This is due to the high level of technology required to fly airplanes to such high altitudes while making the aircraft efficient to operate. That said, airplanes are routinely operated above 65kft and represent a significantly more mature technology than high-altitude airships or floating pipe system. Utilizing existing used aircraft reduced startup costs but the lack of high altitude capability limits existing aircrafts usefulness for geoengineering. Second-hand aircraft may require increasing maintenance and have limited useful life. Modifying existing aircraft does improve high altitude capability but eliminates the cost advantage to using existing systems.

Table 20: Summary of all systems examined. 1M tonnes per year, all costs in FY10 dollars.

System Type	Altitude (kft)	Altitude (km)	RDT&E and Acquisition Costs (\$B)	Recurring Cost per Kg (Less RDT&E, Acquisition Costs)	Yearly Total Cost Including depreciation and Interest (\$B)
Boeing 747 Class	45	13.7	\$0.820	\$1.00	\$1.130
Modified Gulfstream Class	60	18.3	\$3.230	\$2.15	\$2.890
New Design Airplane	40	12.2	\$2.010	\$0.30	\$0.610
New Design Airplane	60	18.3	\$2.070	\$0.35	\$0.670
New Design Airplane	70	21.3	\$5.580	\$0.56	\$1.460
New Design Airplane	80	24.4	\$7.780	\$0.60	\$1.850
New Design Airplane	100	30.5	\$11.400	\$0.75	\$2.570
Gun (Mark 7 16")	91	27.7	\$0.340	\$137.00	\$136.760
Gun (Modernized Mark 7)	91	27.7	\$0.550	\$18.90	\$18.900
Hybrid Airship	66	20.0	\$4.000	\$0.35	\$0.990
Hybrid Airship	82	25.0	\$5.900	\$0.40	\$1.370
Hybrid Airship	98	30.0	\$7.500	\$0.80	\$2.030
Rocket	100	30.5	\$41,700.000	\$2,090.00 ⁴⁹	\$2,090.000
Floating Slurry Pipe	70	21.3	\$24.200	\$0.25	\$4.140
Floating Gas Pipe	70	21.3	\$58.640	\$0.63	\$10.060

Gun systems, simialar to the 16" Naval guns of the Iowa class battleship provide the solution with the lowest initial investment due to technological maturity. The large number of shots required to lift 1M, 3M, or 5M tonnes of mass drives up the cost of projectiles and barrel relining making guns a costly system. Even doubling projectile payload, halving projectile cost, and increasing barrel resilience, gun recurring costs were orders of magnitude more than other systems. For guns to be competitive, projectile costs must be reduced significantly or projectile payload must be increased without affecting projectile height capability.

Slurry pipes and gas pipes supported by floating platforms may be promising solutions, but the technical challenges associated with them require a more detailed look to identify required technological advancements and develop maturation plans to for those technologies. Developing and producing large floating paltforms on the order of 300 m in diameter with $14 \times 10^6 \text{ m}^3$ of helium to support the pipe is within the realm of possibility but at a high cost approaching \$0.5B each. The pipe system's high operating pressures and tensile strength requirments bring the feasibility of this system into question. The pipe itself will require advanced materials and significant engineering to withstand the immense pressures and forces acting on it. Once developed, the minimal electricity and personnel costs allowed the pipe systems to achieved the lowest

⁴⁹ This value is the acquisition costs of the launch vehicles per kilogram flown. Operations costs are small in comparison and were not calculated due to the high cost of rockets.

recurring cost per kilogram of all systems examined. At under \$0.20 per kilogram, the pipe systems have the cheapest operating costs on a per-kilogram basis. Assuming the pipes and platforms do not need extensive maintenance or replacement the yearly operating costs remain low. This makes pipes the most promising system for long duration geoengineering operations. After ample time for development, pipe systems may replace lower risk airplanes or airships once their service life has been expended.

Figure 40 provides a comparison of all the systems yearly costs (including depreciation, interest, and operation). The high altitude capability of guns and rockets comes at an extremely high cost. The large cost associated with developing high altitude airship and airplane systems is dwarfed by the costs of other non-aircraft high altitude systems. Even with generous uncertainties on the new aircraft and airship systems (shown as shaded regions), the costs of rockets and guns dwarf the cost of aircraft systems. Airships manage to beat out aircraft at high altitude due to their significant advantage in fuel burn and slightly lower development and acquisition costs. While airplanes provide flexibility, having low costs at all altitudes, airships are better suited to large payload, high altitude operations. Gas and slurry pipes may provide a cost competitive solution if low end estimates are accurate but, with considerably higher technological risk, their RDT&E and acquisition cost poses large uncertainties and may exceed \$20B even if they prove technically feasible.

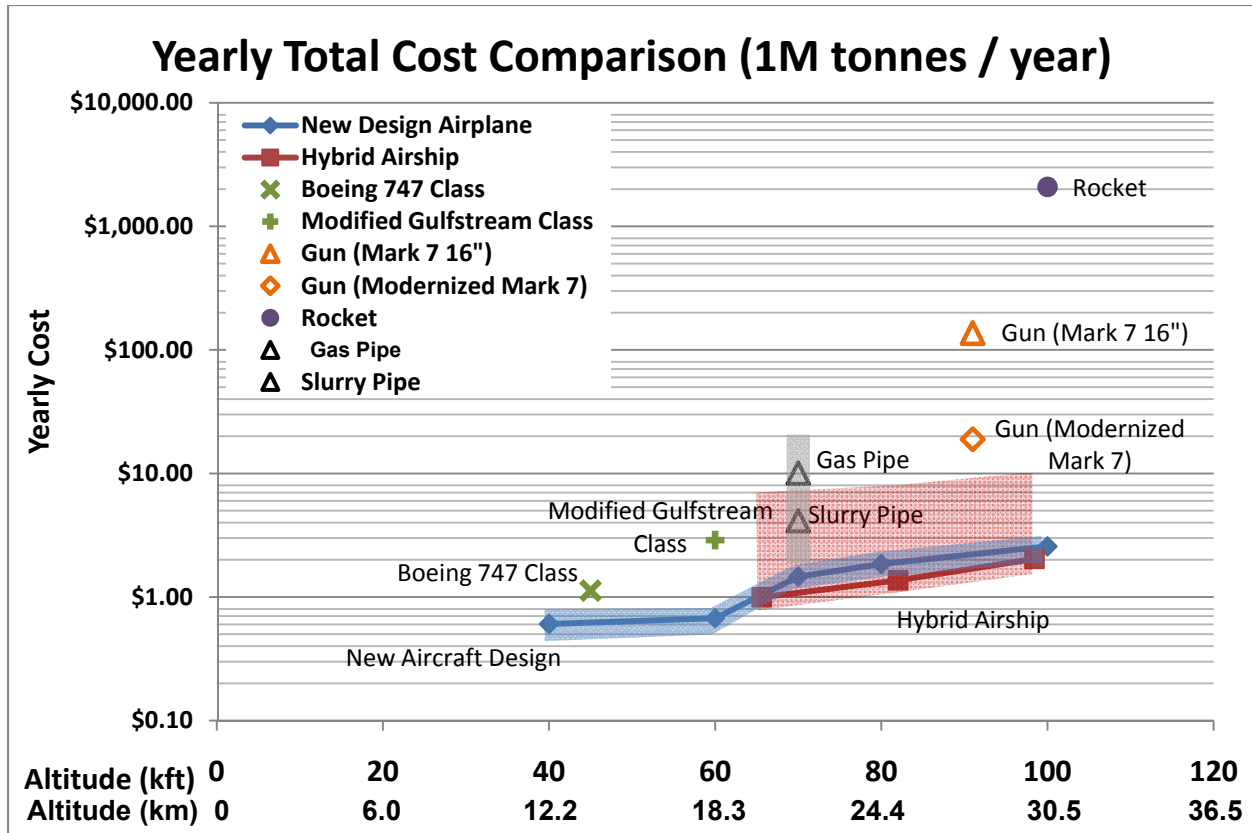

Figure 40: Comparison of yearly costs for various geoengineering systems. Shaded regions show uncertainty in cost estimates.

Figure 41 provides a comparison of the recurring costs per kilogram to transport that kilogram to altitude. Depreciation and interest costs are neglected. The slurry and gas pipe systems are cheap to operate due to their low personnel costs. Actual maintenance costs for the pipe systems are difficult to predict and may increase these operating costs significantly. With operations costs below \$1 / kg, the airplane and airship are systems that are affordable to operate at all altitudes. Even expensive airplane systems such as modified business jets come in at only \$2 / kg to altitude. This is compared to over \$10 to \$100 / kg for guns.

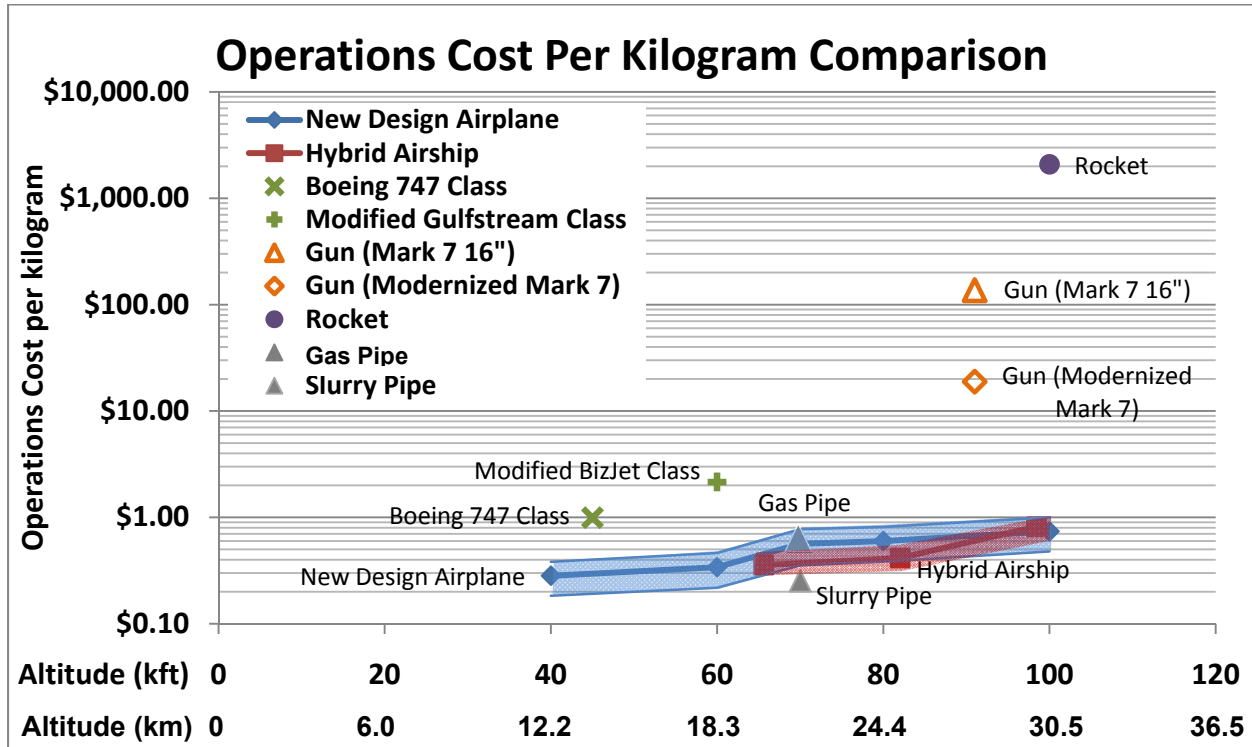

Figure 41: Recurring cost per kilogram for each system. This recurring cost per kilogram only considers operations costs and does not include depreciation and interest costs. Uncertainty shown by shaded areas.

When comparing the cost breakdown for the various systems one can see what drives the cost for each (Table 21). The airship is able to achieve lower total yearly costs over airplanes due to significantly less fuel burn. Even with the long duration missions increasing crew costs, the fuel savings accounts for half of the difference in cost between the two systems. The reduced development and acquisition cost of the airships serves to reduce depreciation and interest costs accounting for the remaining advantage airships have in yearly cost. The pipe systems costs are dominated by the interest and depreciation costs since that system is inexpensive to operate. This is even more noticeable on the slurry pipe system requiring 100 pipes and platforms. Clearly a small escalation in development cost of those systems will have a large impact on their annual cost. The gun system's cost is driven primarily by the cost of the shells. The low payload fraction of the shells and the need for over 2 million shots means a small increase in shell cost will drive annual costs up significantly.

Table 21: Comparison of yearly operating, depreciation, and interests cost for the various systems

	Fuel, Electrical, Powder/shells Costs	Crew Costs	Maintenance Costs	Depreciation Costs	Interest Costs	Total Yearly Costs
Airplane 25 km (80kft)	\$0.239B	\$0.076B	\$0.284B	\$0.350B	\$0.901B	\$1.850B
Airship 25 km (80kft)	\$0.006B	\$0.168B	\$0.249B	\$0.266B	\$0.685B	\$1.370B
Slurry Pipe 21 km (70kft)	\$0.011B	\$0.120B	\$0.121B	\$1.090B	\$2.800B	\$4.140B
Gas Pipe 21 km (70kft)	\$0.011B	\$0.331B	\$0.293B	\$2.640B	\$6.790B	\$10.060B
Gun (Modern) 27.6 km (90kft)	\$18.600B	\$0.002B	\$0.252B	\$0.009B	\$0.006B	\$18.900B

While analysis shows airplane geoengineering is possible up to 30.5 km (100kft), at these altitudes, the need for development of a new high altitude propulsion system provides a large amount of uncertainty to aircraft development costs. Above 24.4 km (80kft), the assumed \$2B cost of engine development could easily swell as has been the case with many recent engine development efforts. One example is the Pratt and Whitney F135 engine effort that was initially projected at \$4.8B and has swelled to over \$7.2B. At altitudes in excess of 60kft, the airship system provides greater propulsion flexibility than airplanes, but the large surface area of the airship requires a carefully designed structure and powerful propulsion system. With no high altitude airship flight heritage, the airship's vulnerability to winds and weather are unknown risks. Above about 80kft, HLA size to generate enough buoyancy as well as the size of the floating platform required to support a gas pipe or slurry pipe become very large. New propulsion for airplanes and airships would need to be developed, with resulting increase in cost estimate uncertainties. In the 80-100 kft range, the relative simplicity of the gun system begins to look attractive despite the high recurring cost of shells, if the payload fraction can be increased.

9.2 Recommendations for Future Work

Additional work is suggested to refine the new airplane and airship designs. Uncertainties in the predicted costs for each can be reduced through more detailed conceptual designs.

Similarly, the floating platform system with a gas pipe or slurry pipe costs appeared competitive with airplanes and airships, but also represented a system with some of the most difficult to predict RDT&E costs. A more thorough look at the floating platform design and the pipe design is required to obtain more accurate cost for that system. A detailed structural analysis of the pipe including modeling of wind effects, optimization of pipe to reduce wind effects, modeling of tapered pipe, and trade studies of distributed floatation and pumping will improve understanding of feasibility and cost.

10 Appendix

10.1 Basing Options

Figure 42 shows 11 potential basing locations. A survey of satellite photos for the various locations allowed verification that these sites have ample space for any required infrastructure improvement to accommodate a large geoengineering fleet.

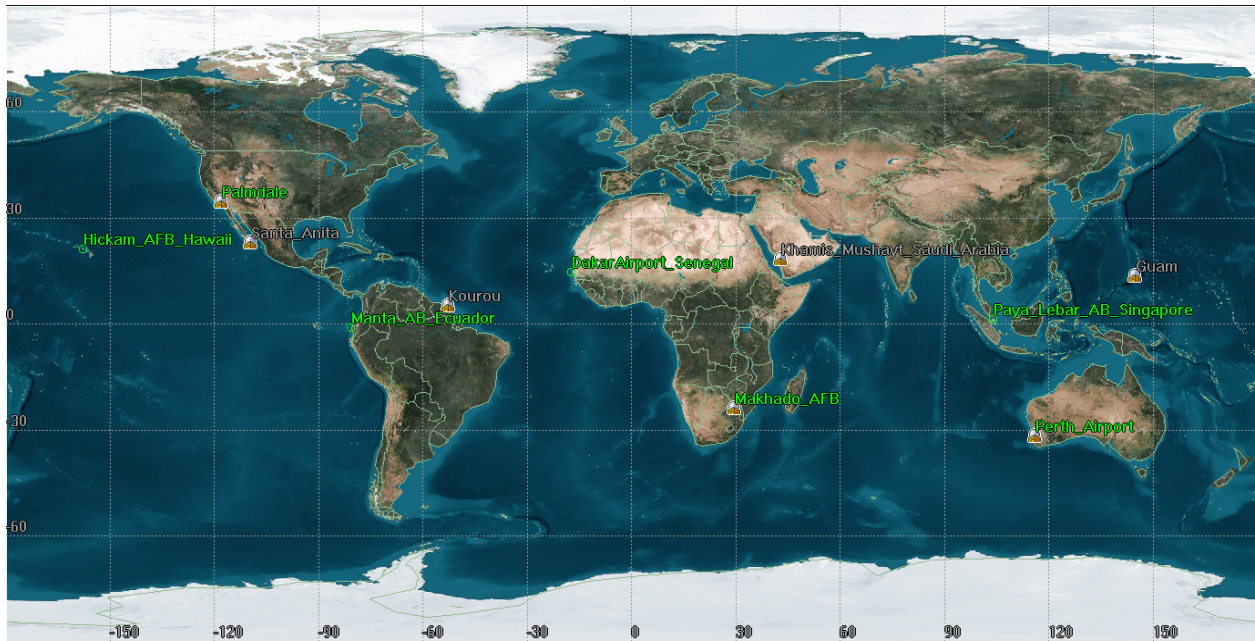

Figure 42: Map of potential basing locations.

10.2 HLA Sizing Equations

0% = 1 Hull

10% = 2 Hull

20% = 3 Hull



$$\text{rad} = \frac{-2\pi L + \sqrt{(2\pi L)^2 - 4\left(20\frac{\pi}{6}\right)(-S)}}{40\frac{\pi}{6}} \text{ [m]}$$

$$\text{Width} = 2 * \text{rad} \text{ [m]}, \text{Height} = 2 * \text{rad} \text{ [m]}, \text{FA} = \frac{1}{2} \pi \text{rad}^2 \text{ [m}^2\text{]}$$

$$\text{For percent heaviness} = 10\%: \text{qs} = 40 \text{ [m]}, S = \frac{\text{vol}}{\text{qs}} \text{ [m}^2\text{]}$$

$$\text{rad} = \frac{-(4\pi L - 2\text{theta} * L) + \sqrt{\left((4\pi L - 2\text{theta} * L)^2 - 4\left(40\frac{\pi}{6}\right) * (-S)\right)}}{80\frac{\pi}{6}} \text{ [m]}$$

$$\text{Width} = 4\text{rad} - \text{rad} \left(1 - \cos\left(\frac{\text{theta}}{2}\right)\right) \text{ [m]}, \text{Height} = 2\text{rad} \text{ [m]}$$

$$\text{FA} = \pi * \text{rad}^2 - \text{rad}^2 * \left(\frac{\text{theta}}{2}\right) \text{ [m}^2\text{]}$$

$$\text{For present heaviness} = 20\%: \text{qs} = 60 \text{ [m]}, S = \frac{\text{vol}}{\text{qs}} \text{ [m}^2\text{]}$$

$$\text{rad} = \frac{-(6\pi L - 4\text{theta} * L) + \sqrt{\left((6\pi L - 4\text{theta} * L)^2 - 4(10\pi) * (-S)\right)}}{20\pi} \text{ [m]}$$

$$\text{Width} = 6 * \text{rad} - 2 * \text{rad} * \left(1 - \cos\left(\frac{\text{theta}}{2}\right)\right) \text{ [m]}, \text{Height} = 2 * \text{rad} \text{ [m]}$$

$$\text{FA} = \left(\frac{3}{2}\right) \pi * \text{rad}^2 - 2 * \text{rad}^2 * \left(\frac{\text{theta}}{2}\right) \text{ [m}^2\text{]}$$

Margins were then added to these sizes to account for crew and/or avionics, payload, and fuel. This results in a final HLA volume shown in the equation below

$$\text{Total Volume} = 1.1 * \text{Vol}_{\text{He}} + \text{Vol}_{\text{Hull}} + 1.2 * \text{Vol}_{\text{Payload}} + 1.1 * \text{Vol}_{\text{fuel}}$$

10.3 HLA Architecture Comparisons

The following plots compare all potential airship solutions examined for geoengineering. They are included to show how constraining the airship size effected airship cost numbers.

10.3.1 Yearly Financed Fleet Operations

Yearly cost includes operations, finance charges, and depreciation. Unconstrained solutions larger than existing hanger facilities are shown.

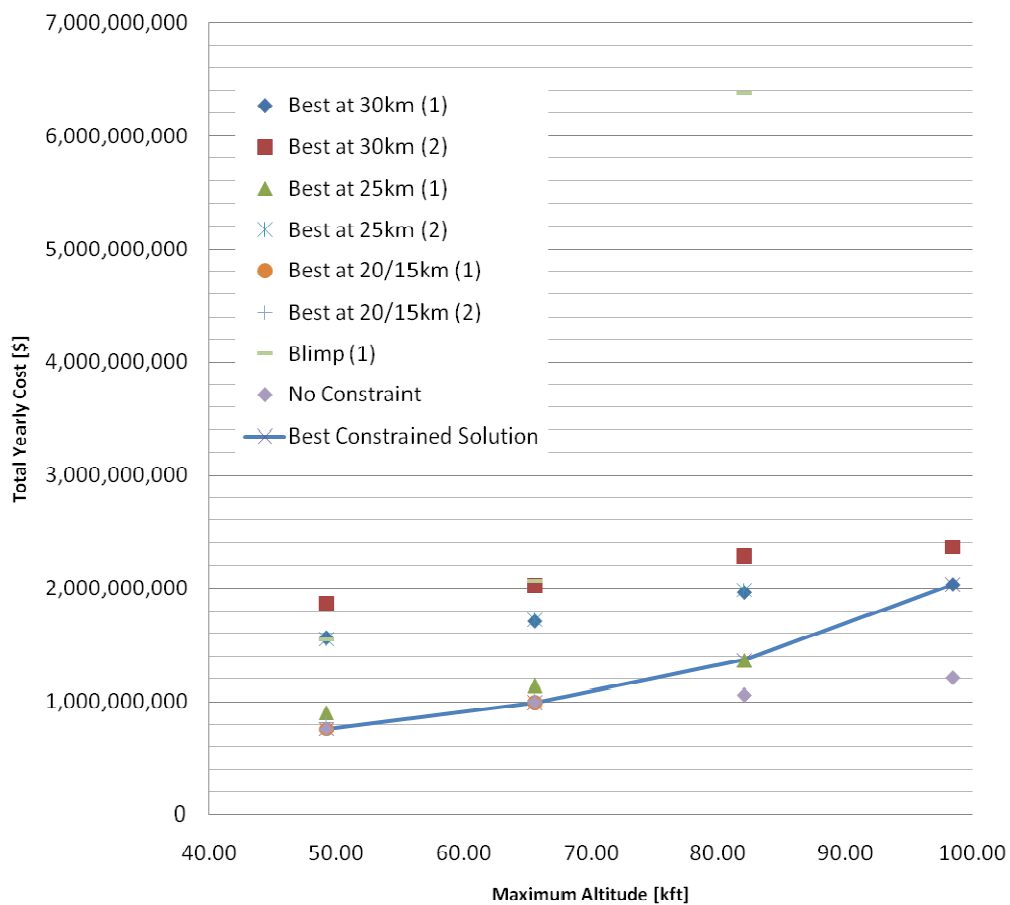

10.3.2 Capital Cost of Fleet

Fleet RDT&E and acquisition costs including solutions larger than existing hanger facilities.

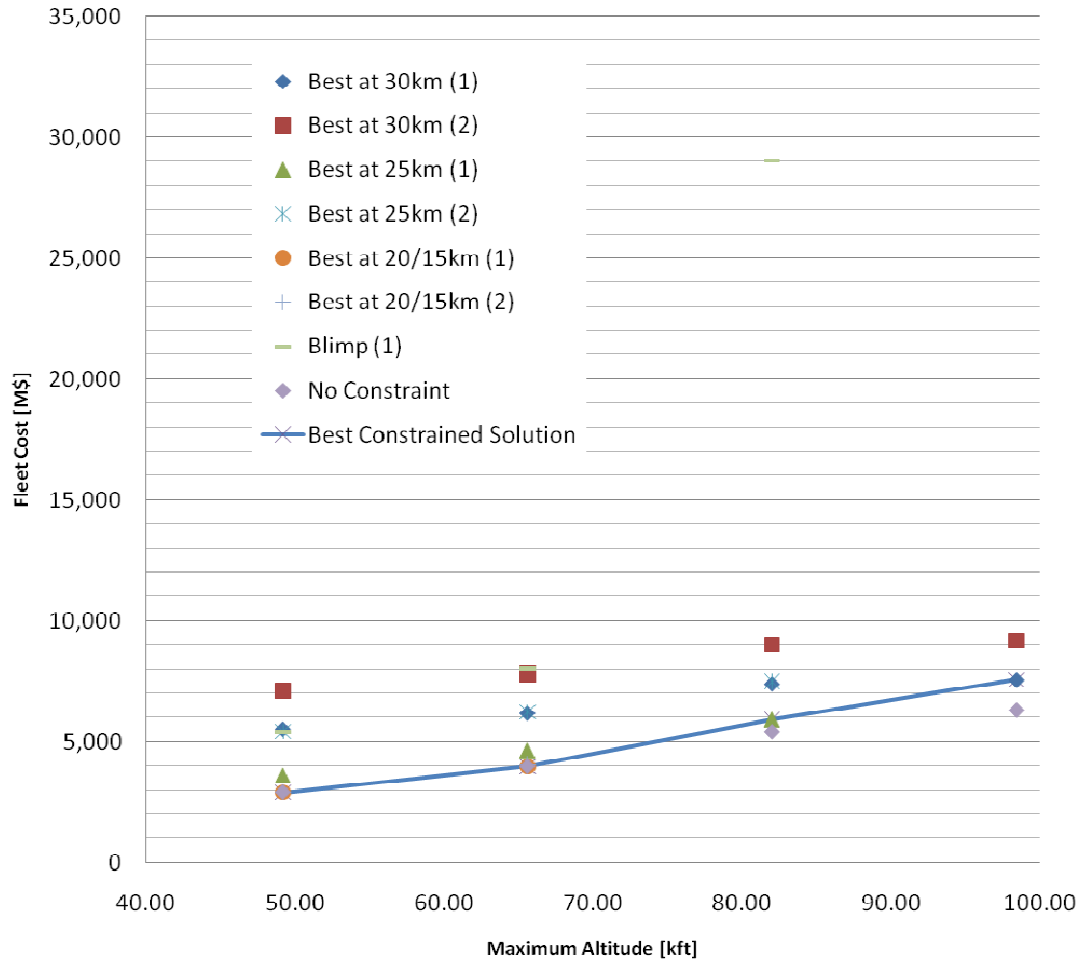

10.3.3 Operations Costs

Operations costs for all airships, including unconstrained solutions larger than existing hanger facilities.

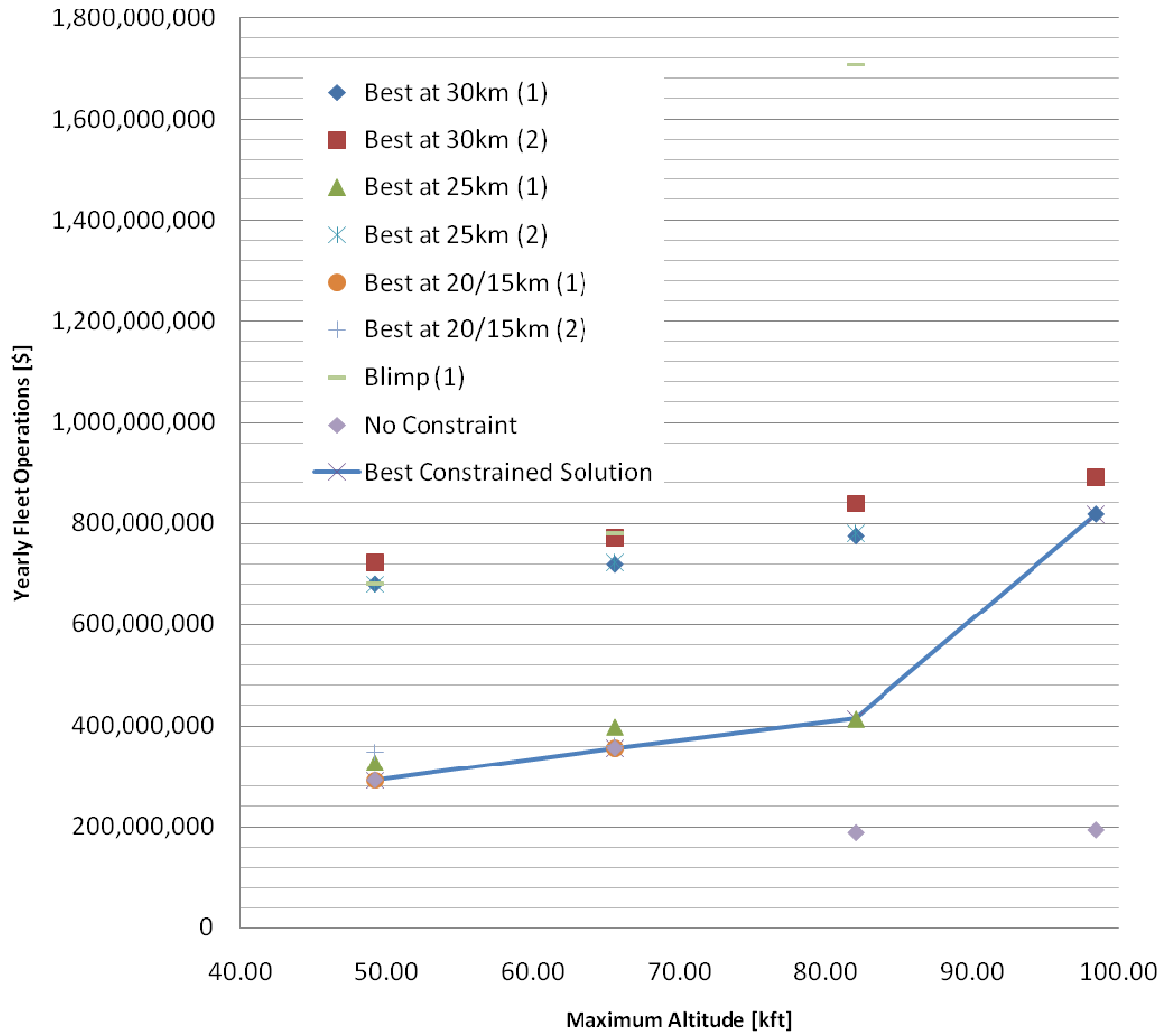

10.4 Existing HLA Hangars

Due to their buoyancy, airships are typically stored and serviced in large hangars affording them protection from severe weather. Several large airship hangars are still in service (for other uses). The airship solutions presented in section 7 are constrained by these hangar sizes.

Hangar #1 at NASA Ames Research Center

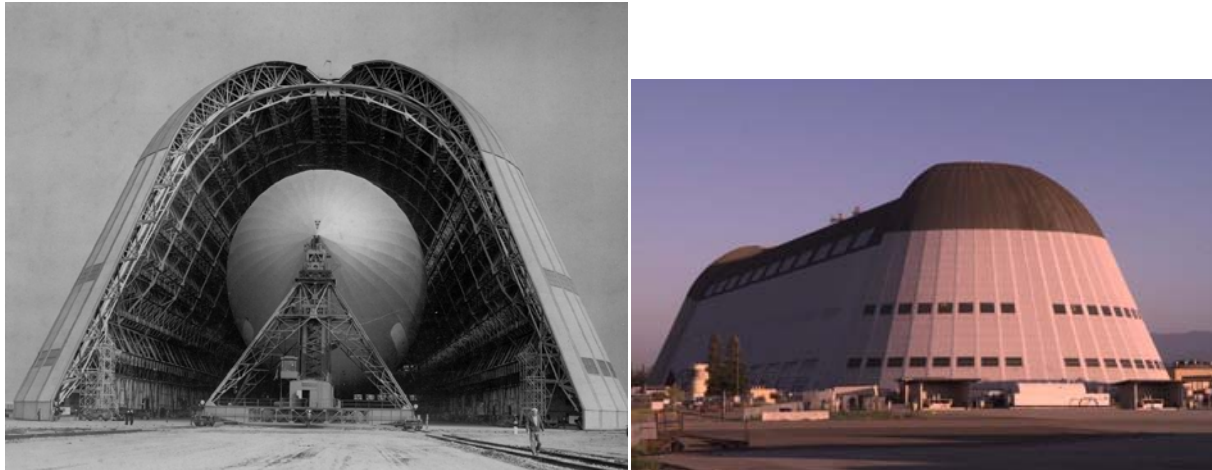

Left: http://www.nasa.gov/centers/ames/multimedia/images/2008/macon_12.html

Right: http://www.nasa.gov/centers/ames/images/content/74046main_mACD99-0136-23.jpg

Hangars #2 and #3 at Naval Air Warfare Center in Lakehurst, NJ



Hangar No. Two Dimensions	
Exterior Length (Maximum)	614 Feet
Exterior Width (Maximum)	217 Feet
Exterior Height (Maximum)	118 Feet

Interior Length, Floor	604 Feet
Interior Width, Floor	155 Feet
Clear Door Height	90 Feet
Clear Door Width	156 Feet
Hangar Floor Area	93,620 Sq. Feet

Hangar No. Three Dimensions	
Exterior Length (Maximum)	414 Feet
Exterior Width (Maximum)	217 Feet
Exterior Height (Maximum)	118 Feet
Interior Length, Floor	404 Feet
Interior Width, Floor	155 Feet
Clear Door Height	90 Feet
Clear Door Width	156 Feet
Hangar Floor Area	62,650 Sq. Feet

Courtesy: <http://www.nlhs.com/hangars.htm>

